

Wiringkit



- D Einbauanleitung
- GB Installation instructions
- F Consignes de montage
- NL Montagehandleiding
- DK Montagevejledning
- N Monteringsinstruksjon
- S Installationsanvisning
- FIN Asennusohje
- I Istruzioni per il montaggio
- E Instrucciones de montaje
- P Instruções de montagem
- GR Οδηγίες εγκατάστασης
- CZ Návod k montáži
- SLO Navodilo za vgradnjo
- SK Montážny návod
- PL Instrukcja montażu
- TR Montaj talimatı
- H Beépítési útmutató
- HR Upute o ugradnji
- BUL Инструкция за монтаж
- RO Instrucțiuni de montaj
- RU Инструкция по монтажу и установке
- LT Montavimo informacija
- LV Iemontēšanas pamācība
- EST Paigaldusjuhend

703504

BMW

- **1-Serie 5-Türer / Door** **F20** 03/14 >>
- **1-Serie 3-Türer / Door** **F21** 03/14 >>
- **2-Serie Coupe** **F22** 03/14 >>

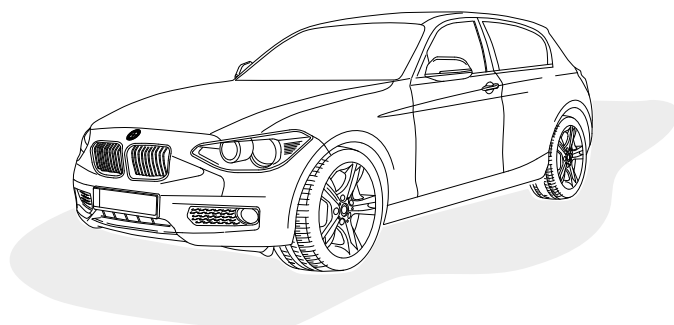
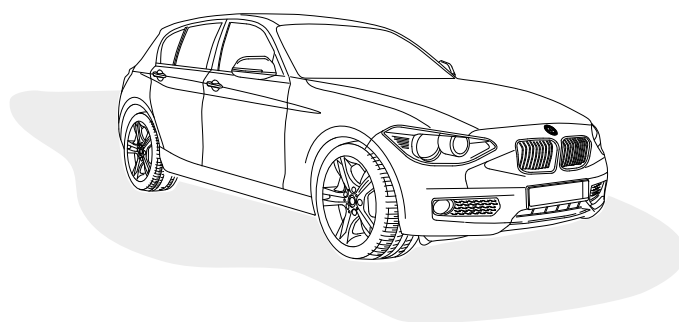
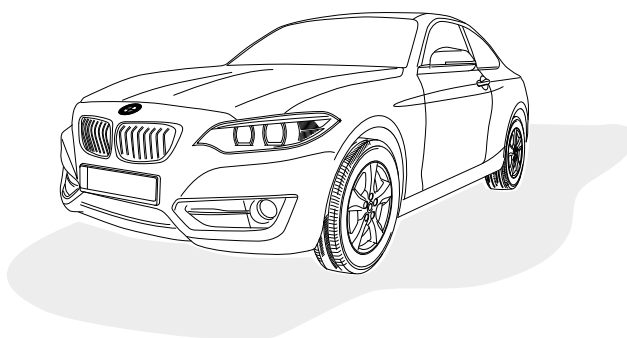

OVERVIEW

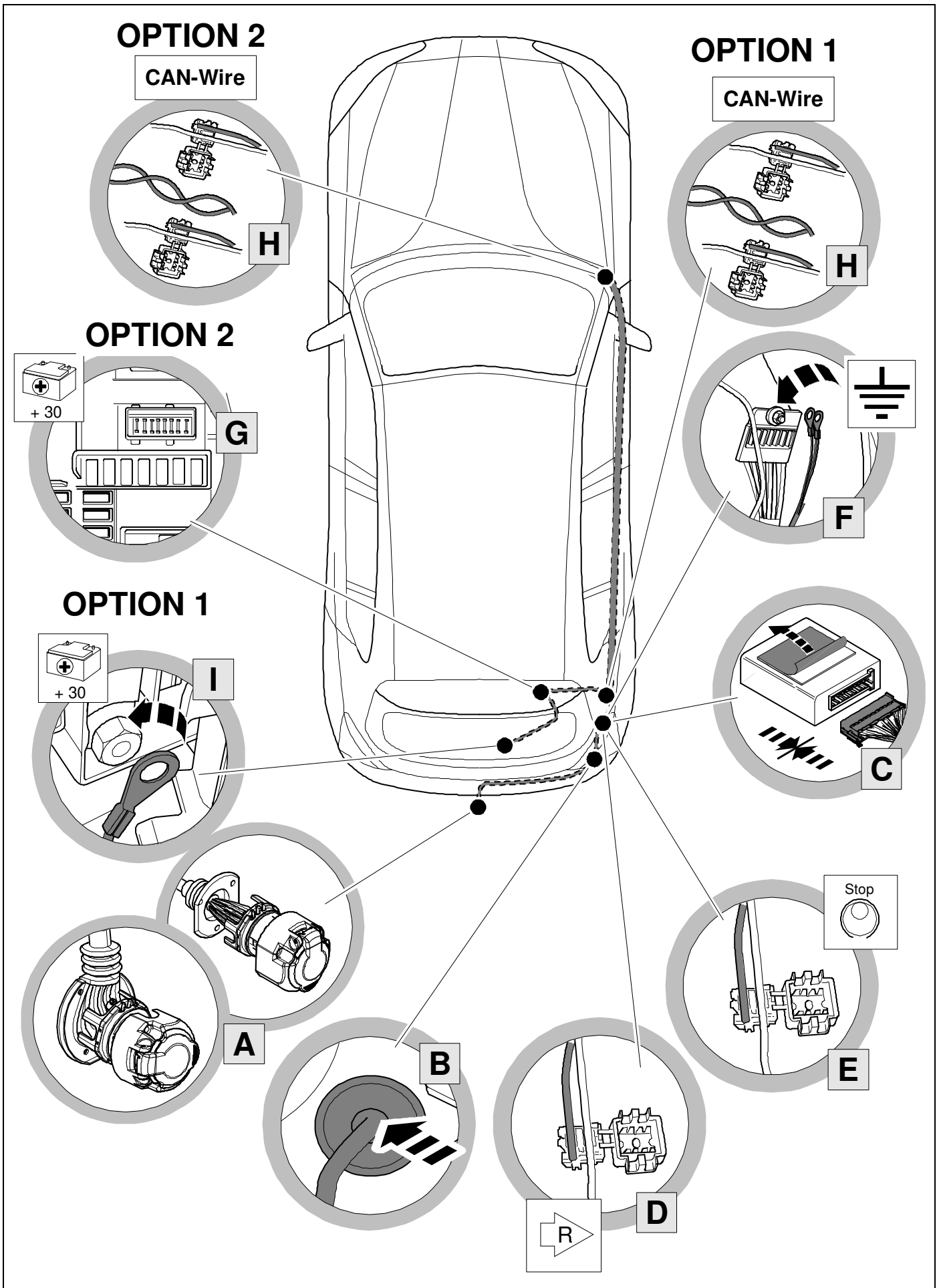

KIT

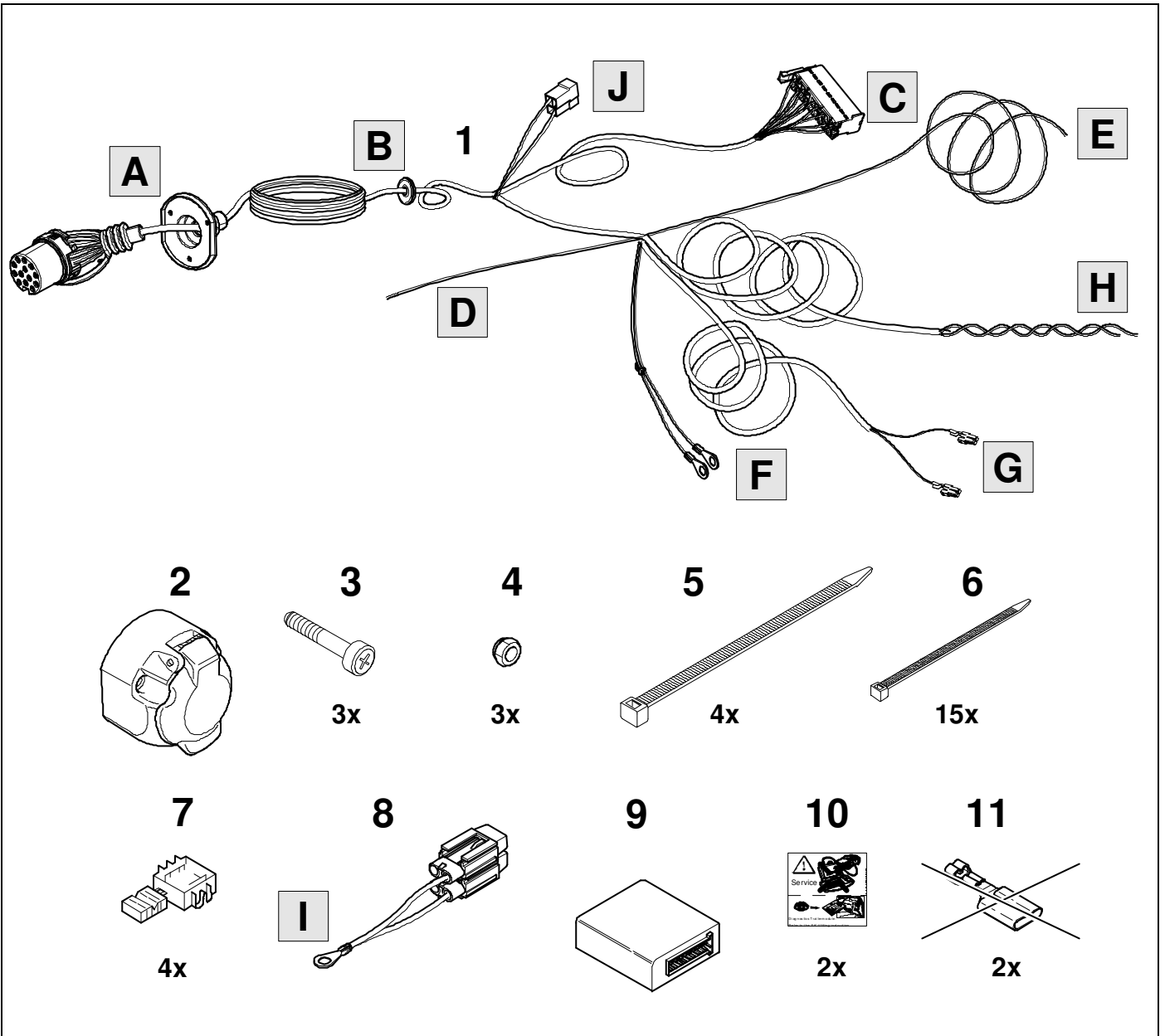

TOOLS

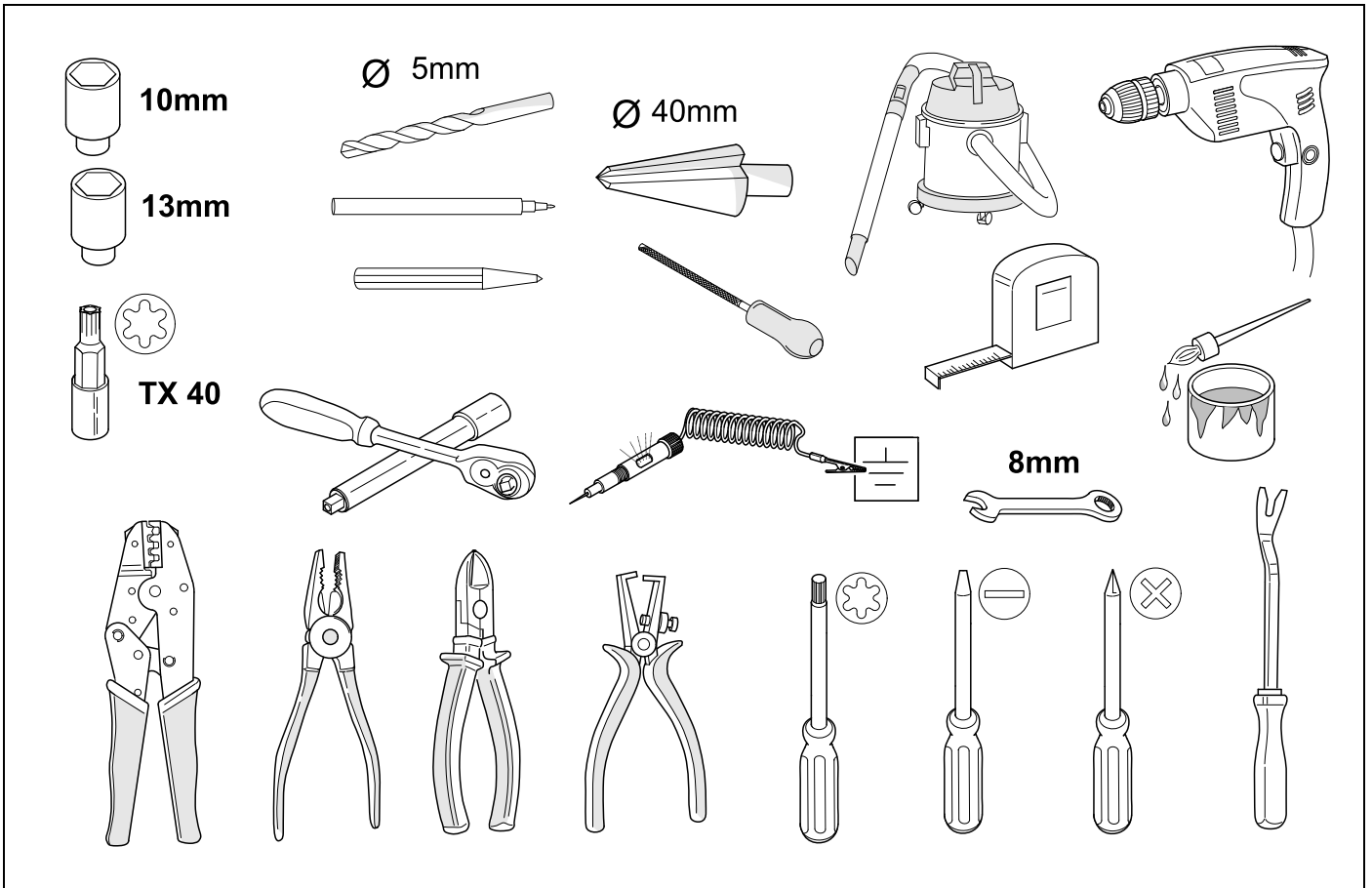

1

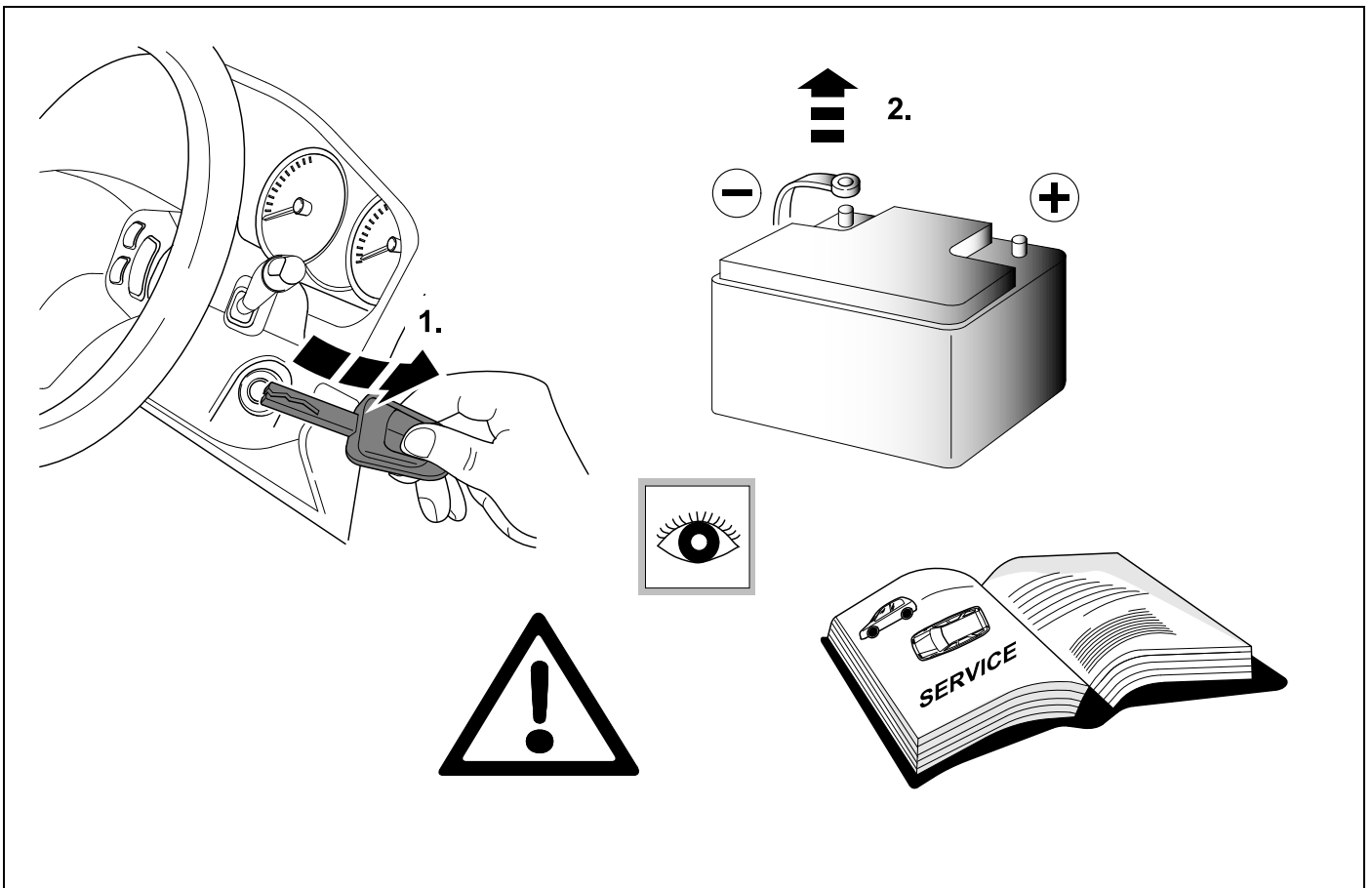

2 REMOVE

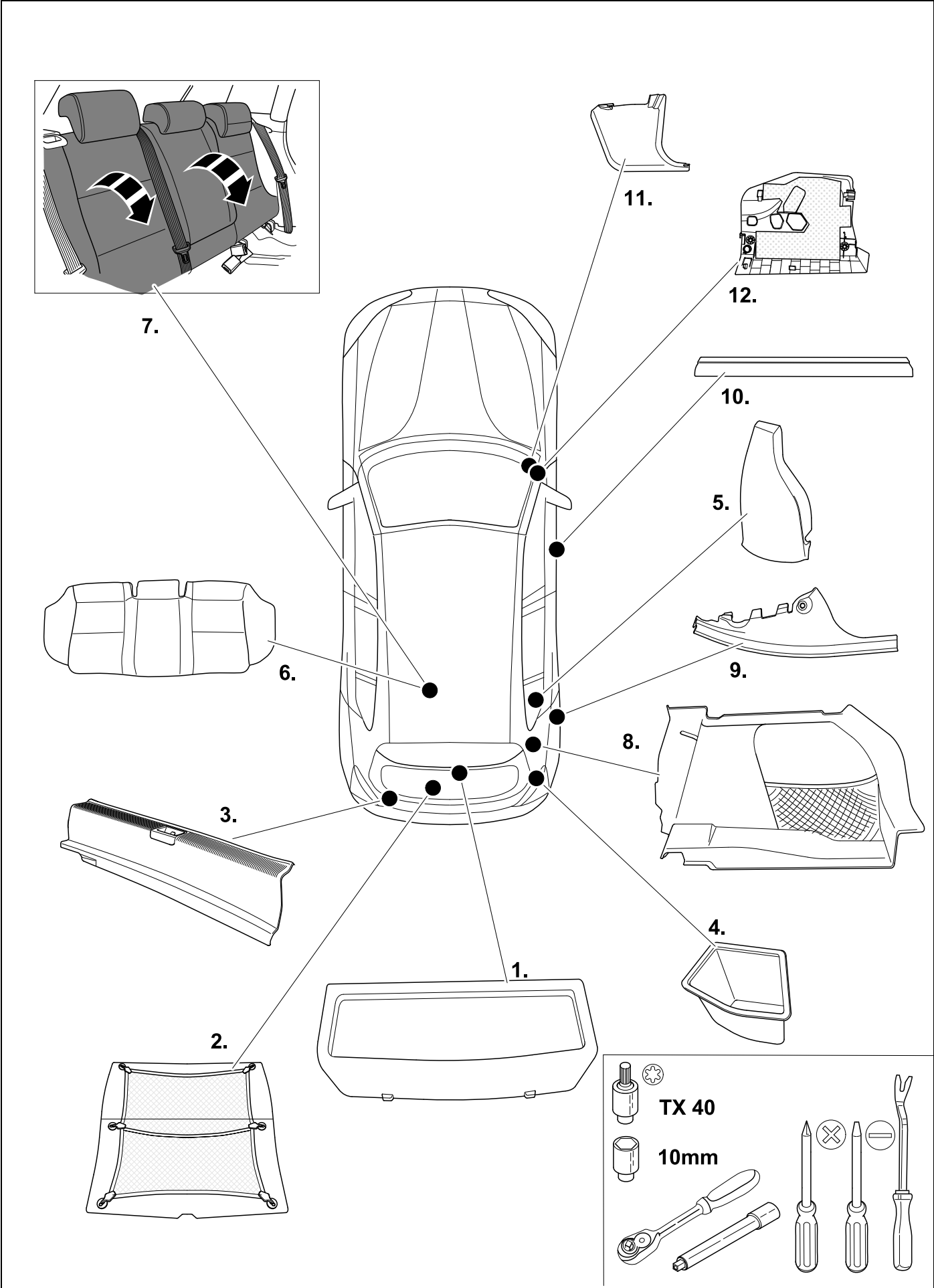

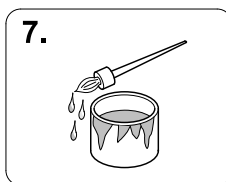
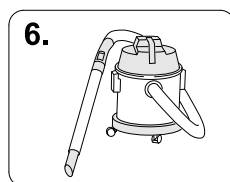
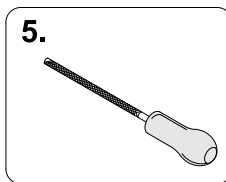
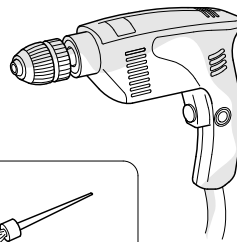
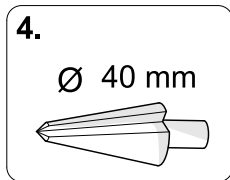
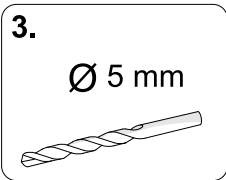
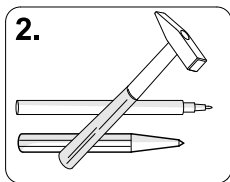
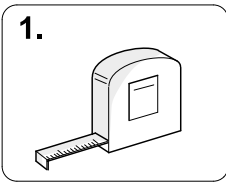
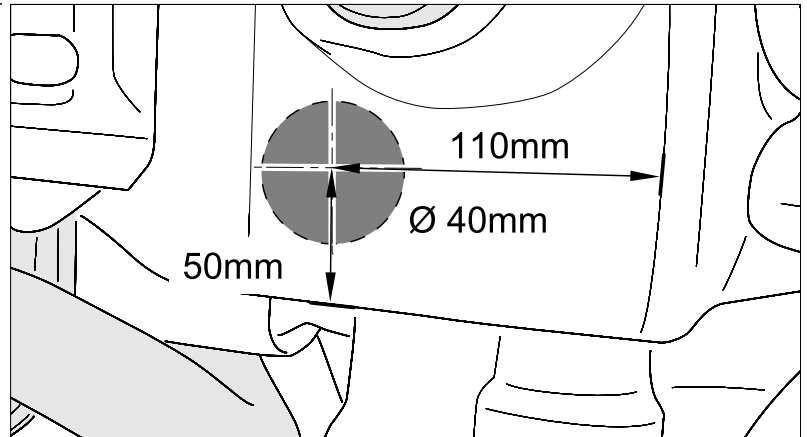
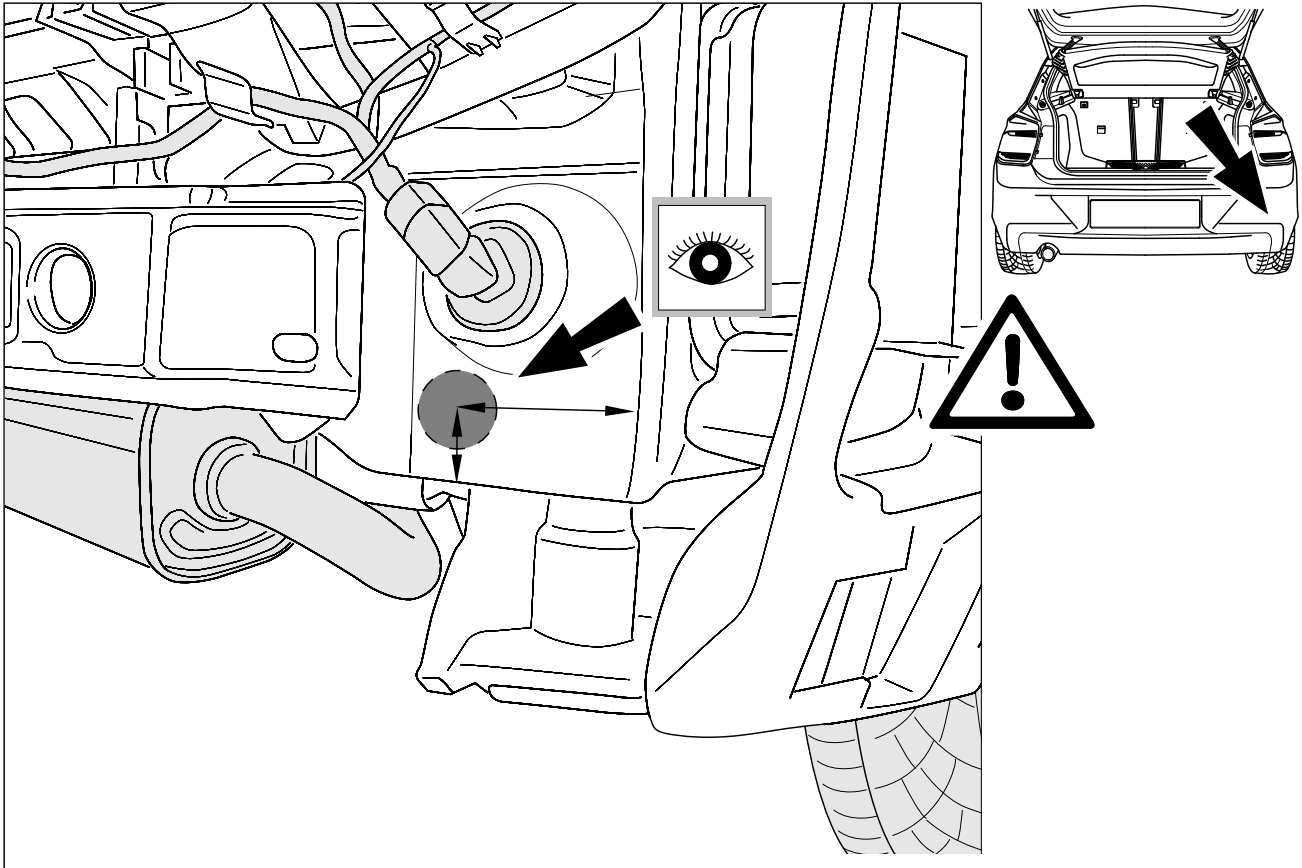

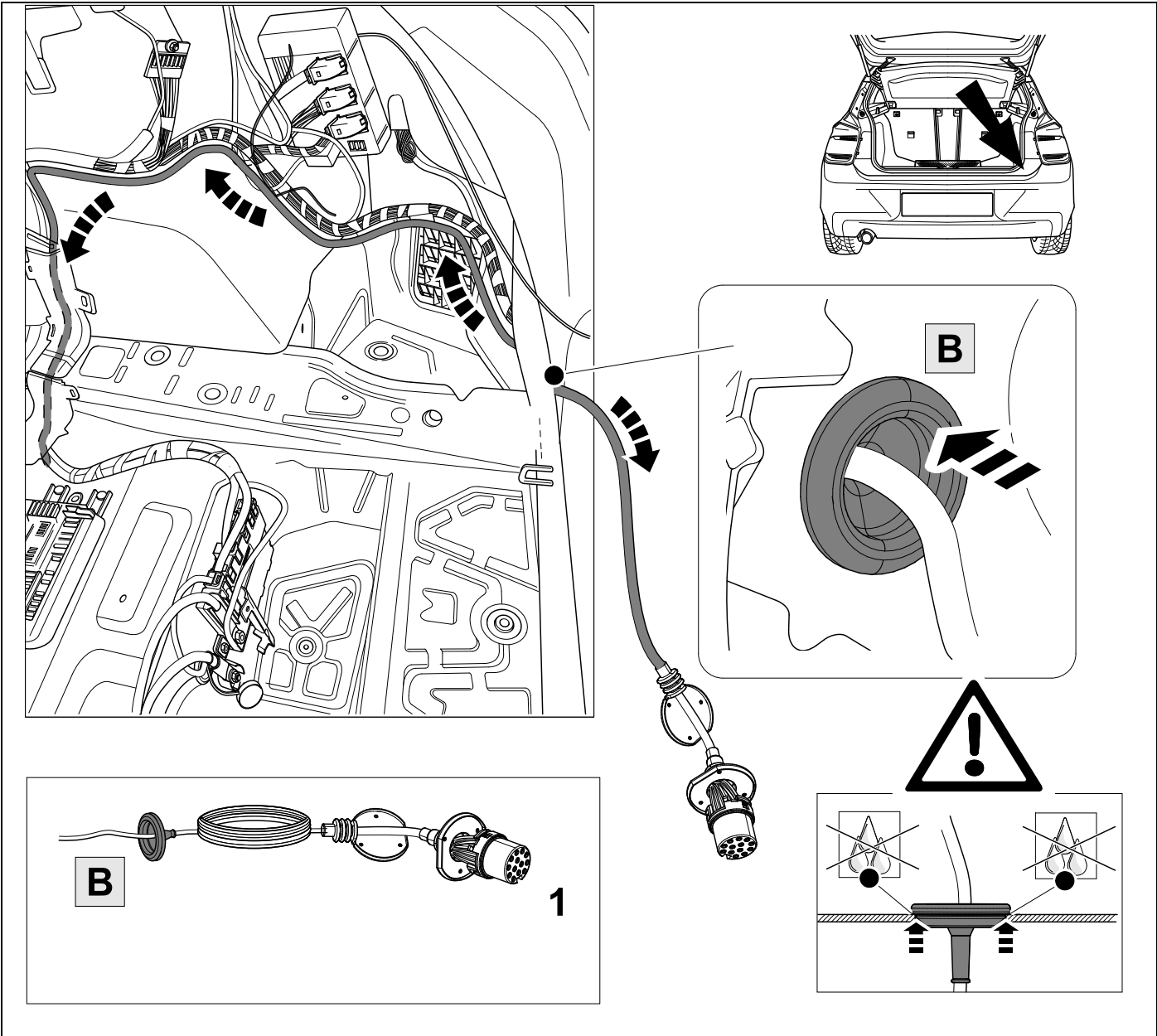

5

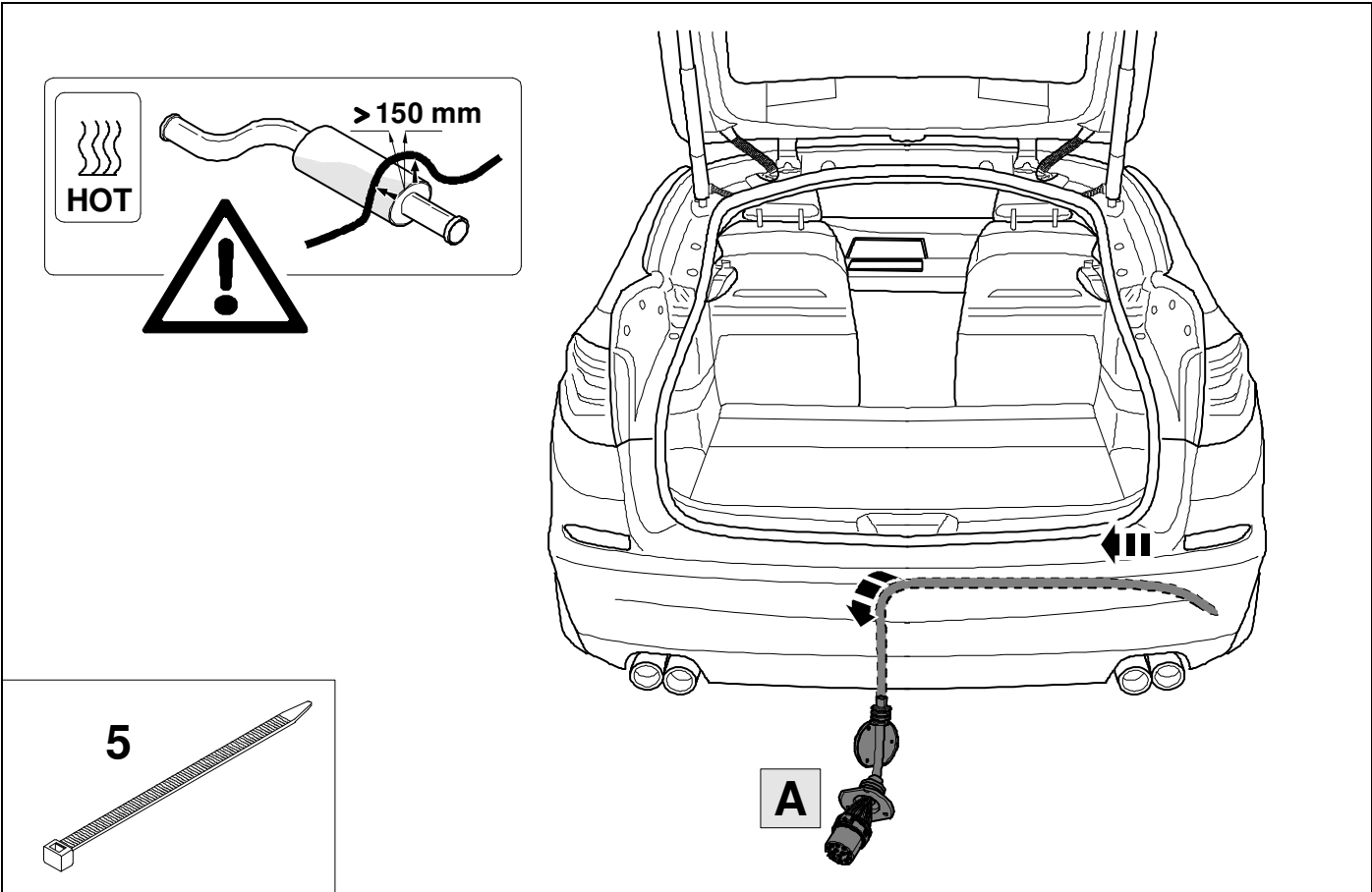

6

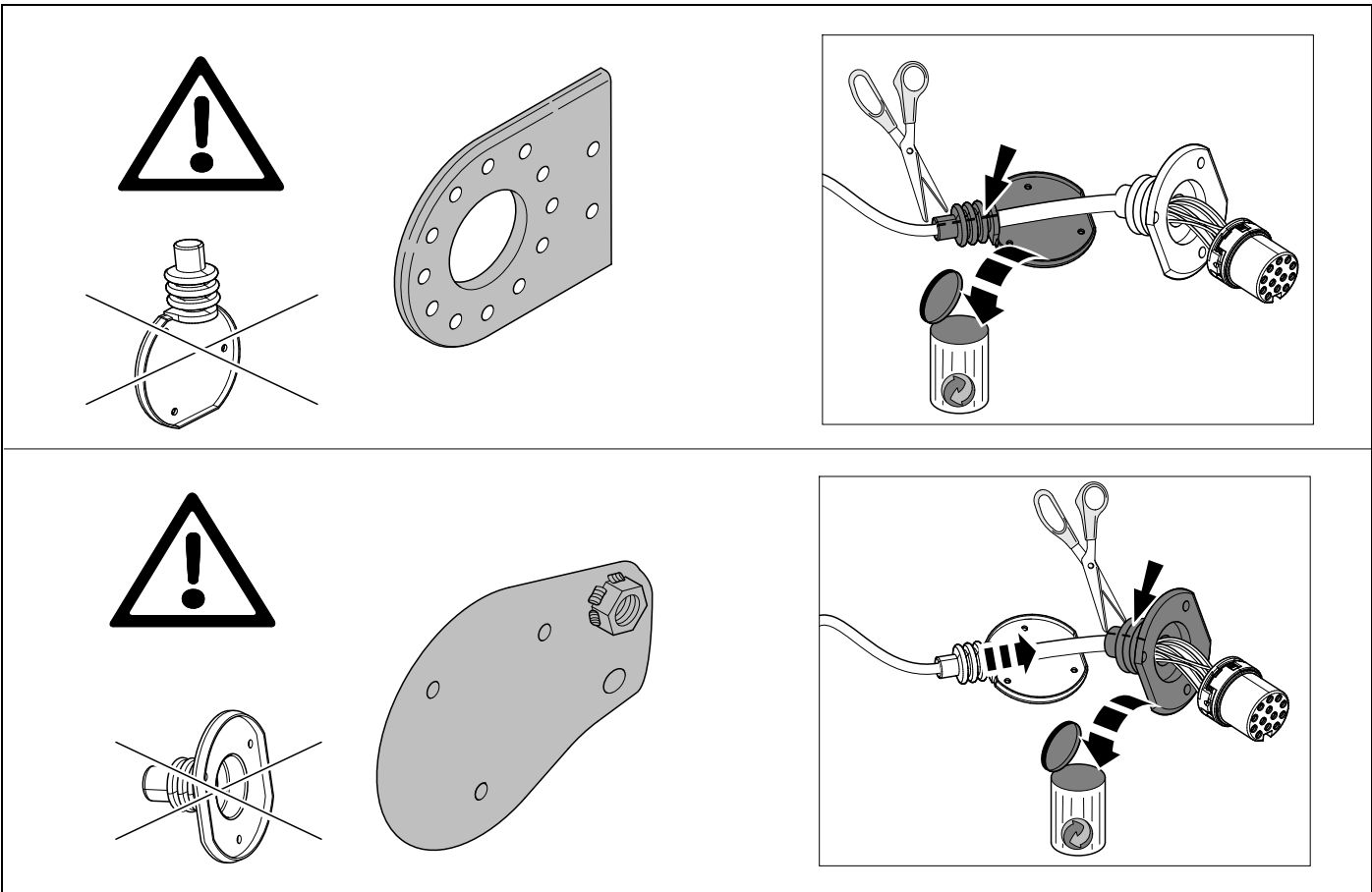

7



9

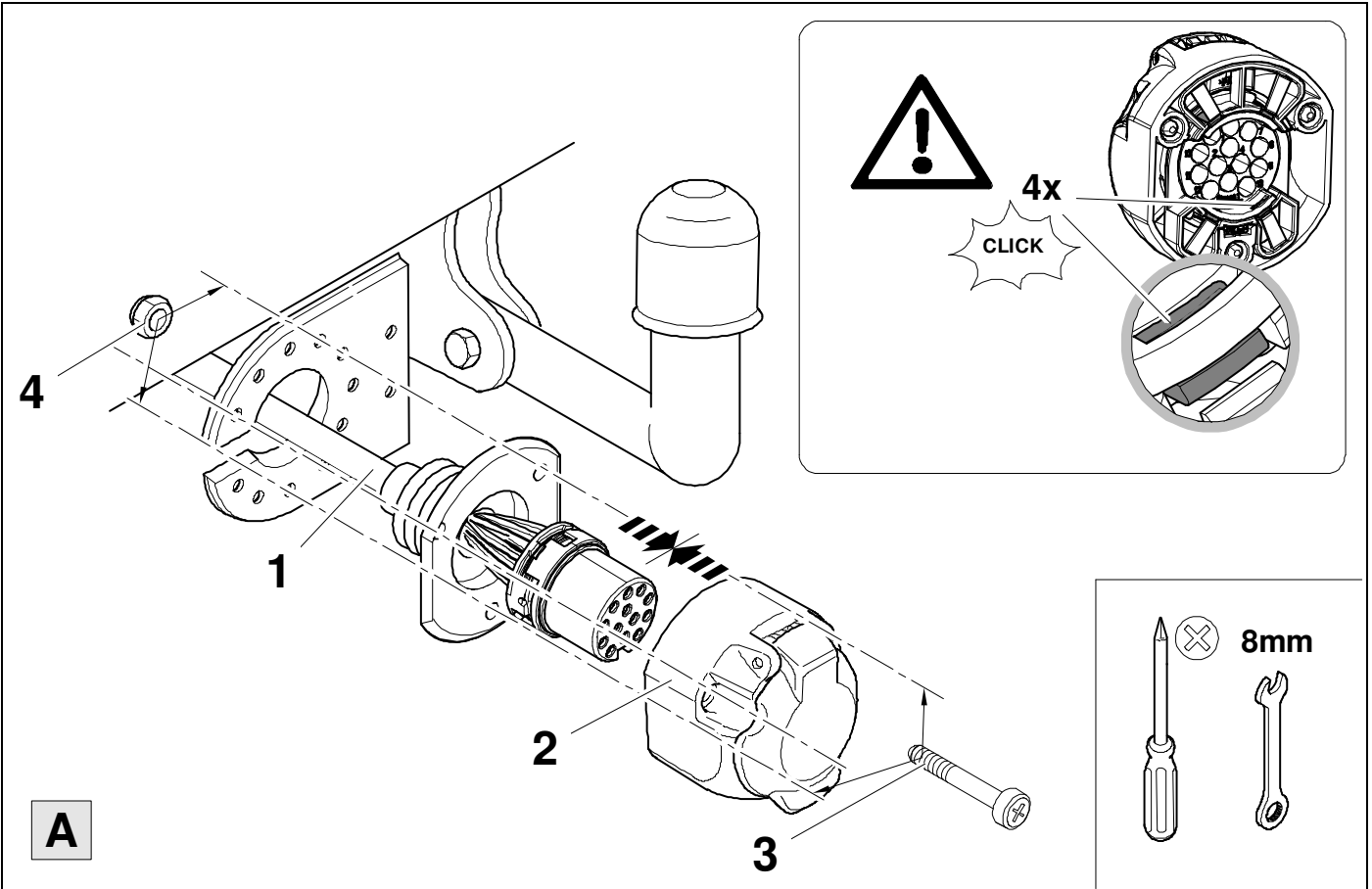

8



9

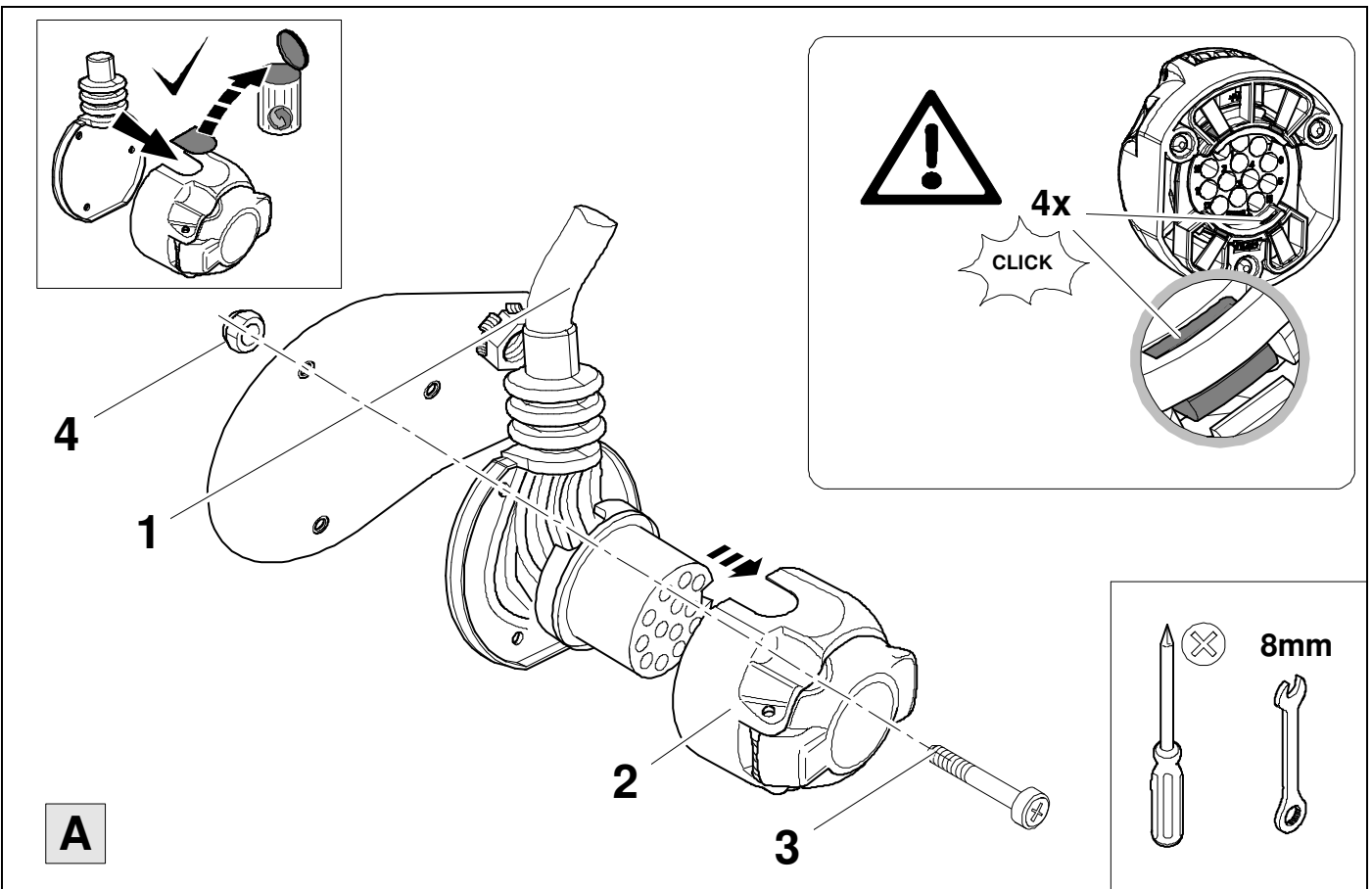



1	bk/wh		8	bu/rd							
2	gy		9	rd/bu							
3	wh/bn		10	ye							
4	bk/gn		11	bn/gn							
5	gy/rd		12	no	-/-						
6	bk/rd		13	bn							
7	gy/bk										

10	bk	wh	gy	gn	rd	bu	ye	bn	pu	or	no
(D)	schwarz	weiß	grau	grün	rot	blau	gelb	braun	violett	orange	nicht belegt
(GB)	black	white	grey	green	red	blue	yellow	brown	purple	orange	not occupied
(F)	noir	blanc	gris	vert	rouge	bleu	jaune	brun	violet	orange	inutilisé
(NL)	zwart	wit	grijs	groen	rood	blauw	geel	bruin	violet	oranje	niet aangesloten
(DK)	sort	hvid	grå	grøn	rød	blå	gul	brun	violet	orange	ikke anvendt
(N)	svart	hvit	grå	grønn	rød	blå	gul	brun	fiolett	oransje	ikke i bruk
(S)	svart	vit	grå	grön	röd	blå	gul	brun	violett	orange	ej använd
(FIN)	musta	valkoinen	harmaa	vihreä	punainen	sininen	keltainen	ruskea	violetti	oranssi	ei varattu
(I)	nero	bianco	grigio	verde	rosso	blu	giallo	marrone	viola	arancione	libero
(E)	negro	blanco	gris	verde	rojo	azul	amarillo	marrón	violeta	anaranja-do	no ocupado
(P)	preto	branco	cinzento	verde	vermelho	azul	amarelo	castanho	violeta	laranja	não ocupado
(GR)	μαύρος	λευκός	Γκρι	πράσινος	κόκκινος	μπλε	κίτρινος	καφέ	Μωβ	πορτοκαλί	δεν είναι κατ'επιτημένος
(PL)	czarny	biały	szary	zielony	czerwony	niebiesko	żółty	brazowy	fioletowy	pomarańczowy	wolny
(CZ)	černý	bílý	šedý	zelený	červený	modrý	žlutý	hnědý	fialový	oranžový	neobsazen
(TR)	siyah	beyaz	gri	yeşil	kırmızı	mavi	sarı	kahverengi	mor	portakal rengi	boş
(H)	fekete	fehér	szürke	zöld	piros	kék	sárga	barna	ibolyakék	narancssárga	nem foglalt
(HR)	crno	bijelo	sivo	zeleno	crveno	plavo	zuto	smeđe	ljubičasto	narandžasto	nije zauzeto
(BUL)	черен	бял	сив	зелен	червен	син	жълт	кафяв	виолетов	оранжев	свободно
(RO)	negru	alb	gri	verde	roșu	albastru	galben	maro	violet	portocaliu	liber
(RU)	черный	белый	серый	зеленый	красный	голубой	жёлтый	коричневый	пурпурный	оранжевый	свободно
(LT)	juoda	balta	pilka	žalia	raudona	mėlyna	geltona	ruda	purpurinė	oranžinė	laisva
(LV)	melna	balta	pelēka	zaļa	sarkana	zila	dzeltena	brūna	purpur-sarkana	oranža	brīvs
(EST)	must	valge	hall	roheline	punane	sinine	kollane	pruun	purpur-punane	oraanž	vaba
(SLO)	črna	bela	siva	zelena	rdeča	modra	rumena	smeđ	vijoličast	oranžen	ni zasedeno
(SK)	čierny	biely	šedý	zelený	červený	modrý	žltý	hnědý	fialový	pomaraňový	neobsadený

11

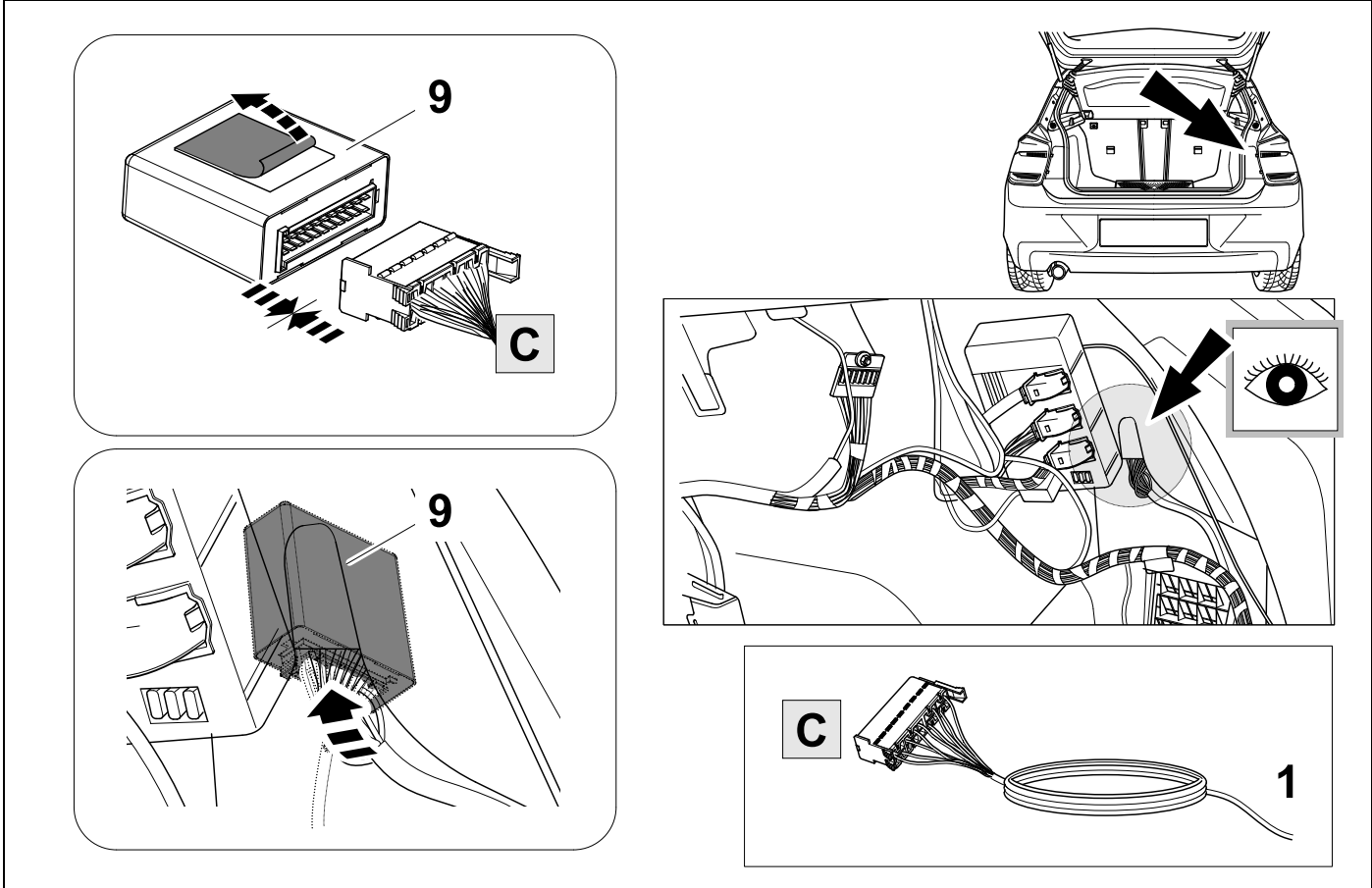

12

👁️ ⇒ 10

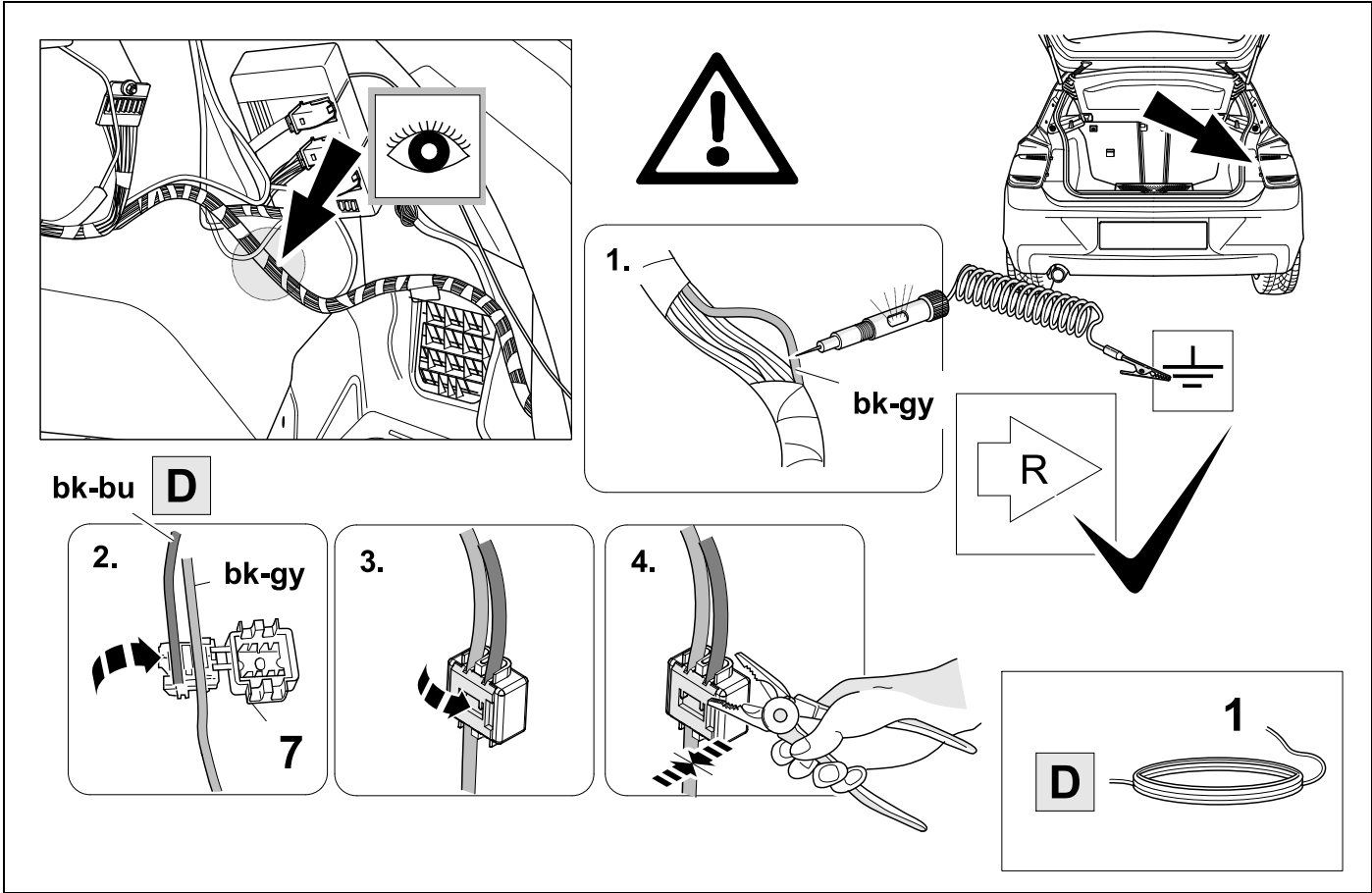

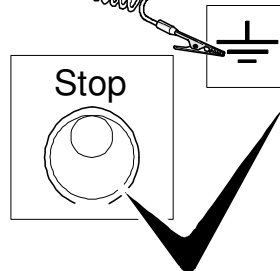
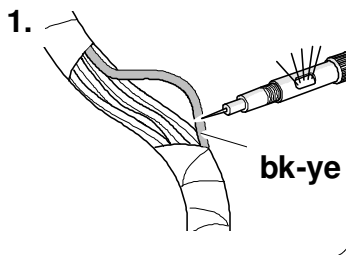
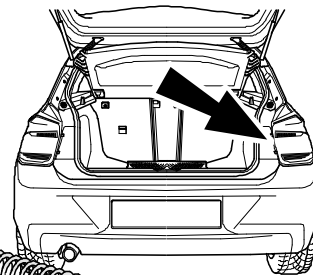
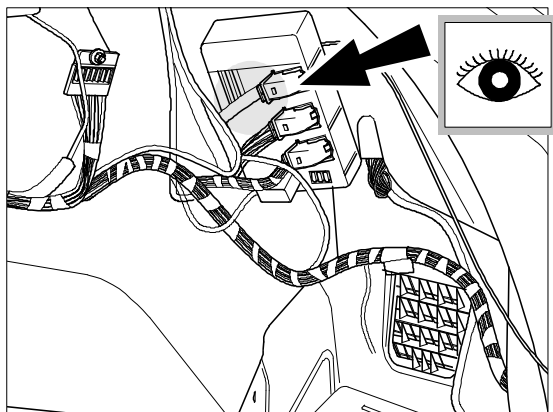

bk-ye **E**

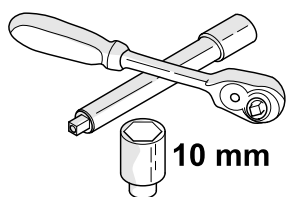
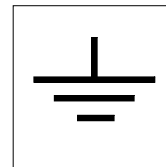
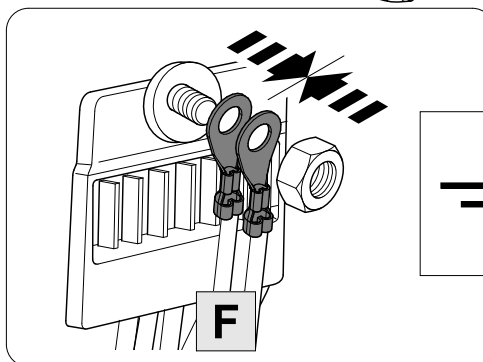
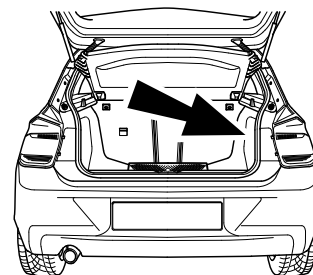
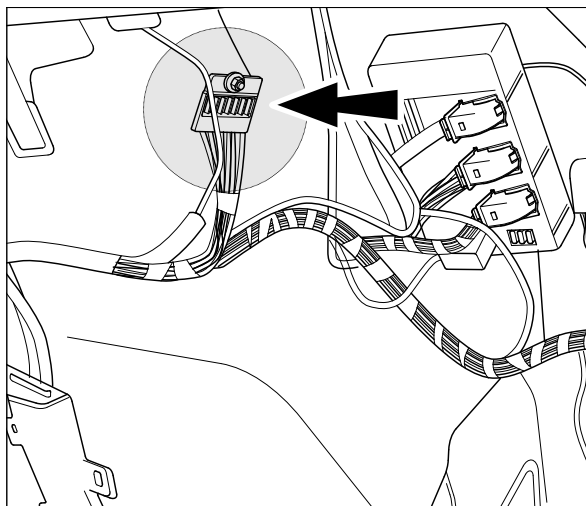
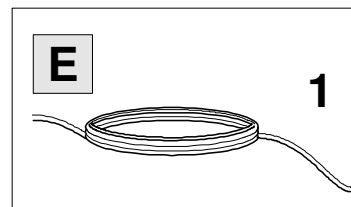
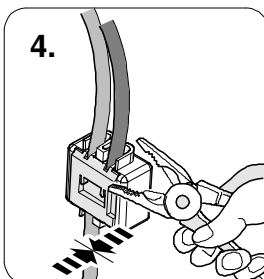
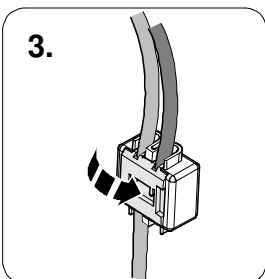
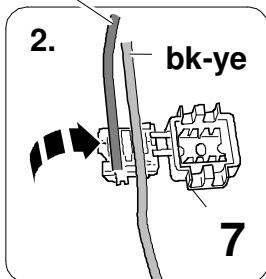

10 mm

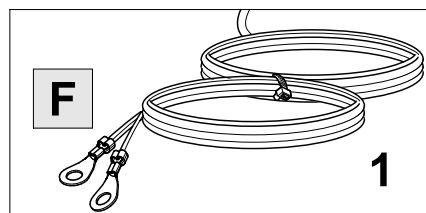

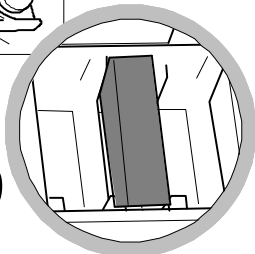
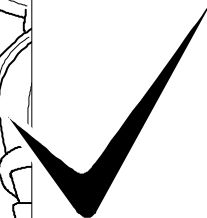
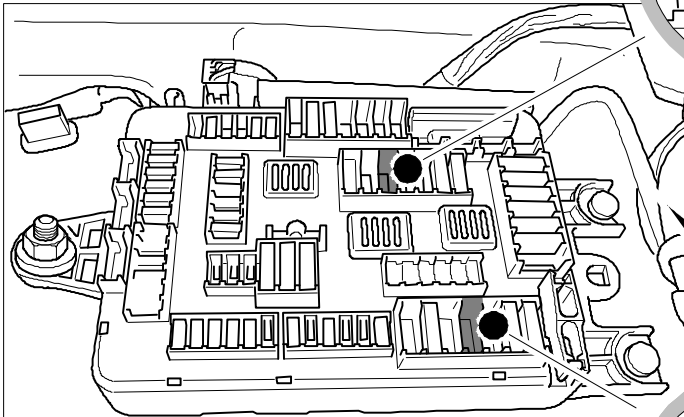
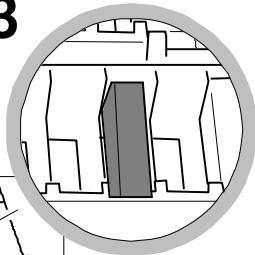

OPTION 1

16

20 - 35



F113

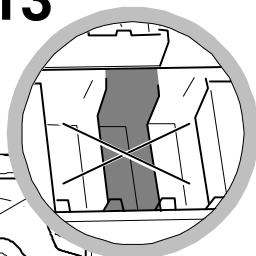

OPTION 2

17 - 35

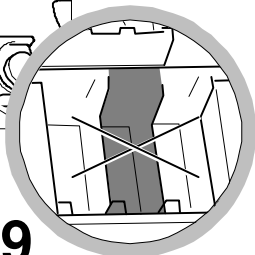
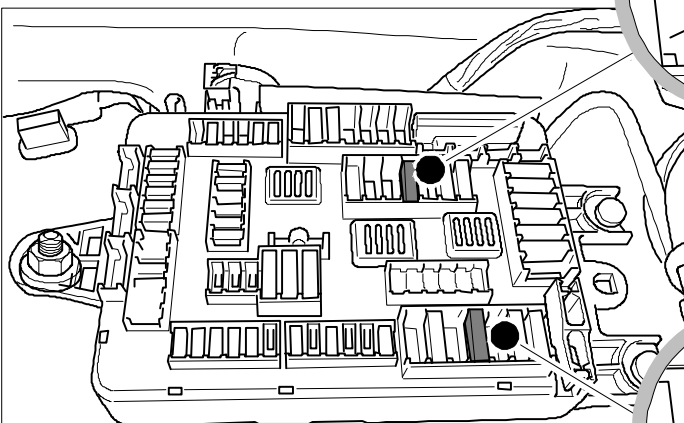

F139

16

OPTION 1



30

+

31

rd	III	➔	20A	⚡	III	rd
rd-bu	III	➔	15A	⚡	III	rd-bu

Diagram showing the installation of a fuse box (8) in a vehicle. The fuse box is connected to the battery (+30) and the vehicle's electrical system. The diagram includes labels for the fuse box (8), the battery (+30), and the vehicle's electrical system (1). The fuse box is connected to the battery (+30) and the vehicle's electrical system (1). The diagram also shows the fuse box (8) connected to the vehicle's electrical system (1) and the battery (+30).

17

OPTION 2



10

1.

G

2.

3.

Diagram showing the connection of a cable (G) to a terminal block (1, 5, 7). The terminal block is labeled 'pu' and 'rd'. The cable (G) is connected to terminal 5.

18

OPTION 2



10

1.

2.

3.

10 mm

G

1

bk

1 4 7

G rd-bu

19

OPTION 2



30

+

31

F113

20A

20A

F139

8

I

20

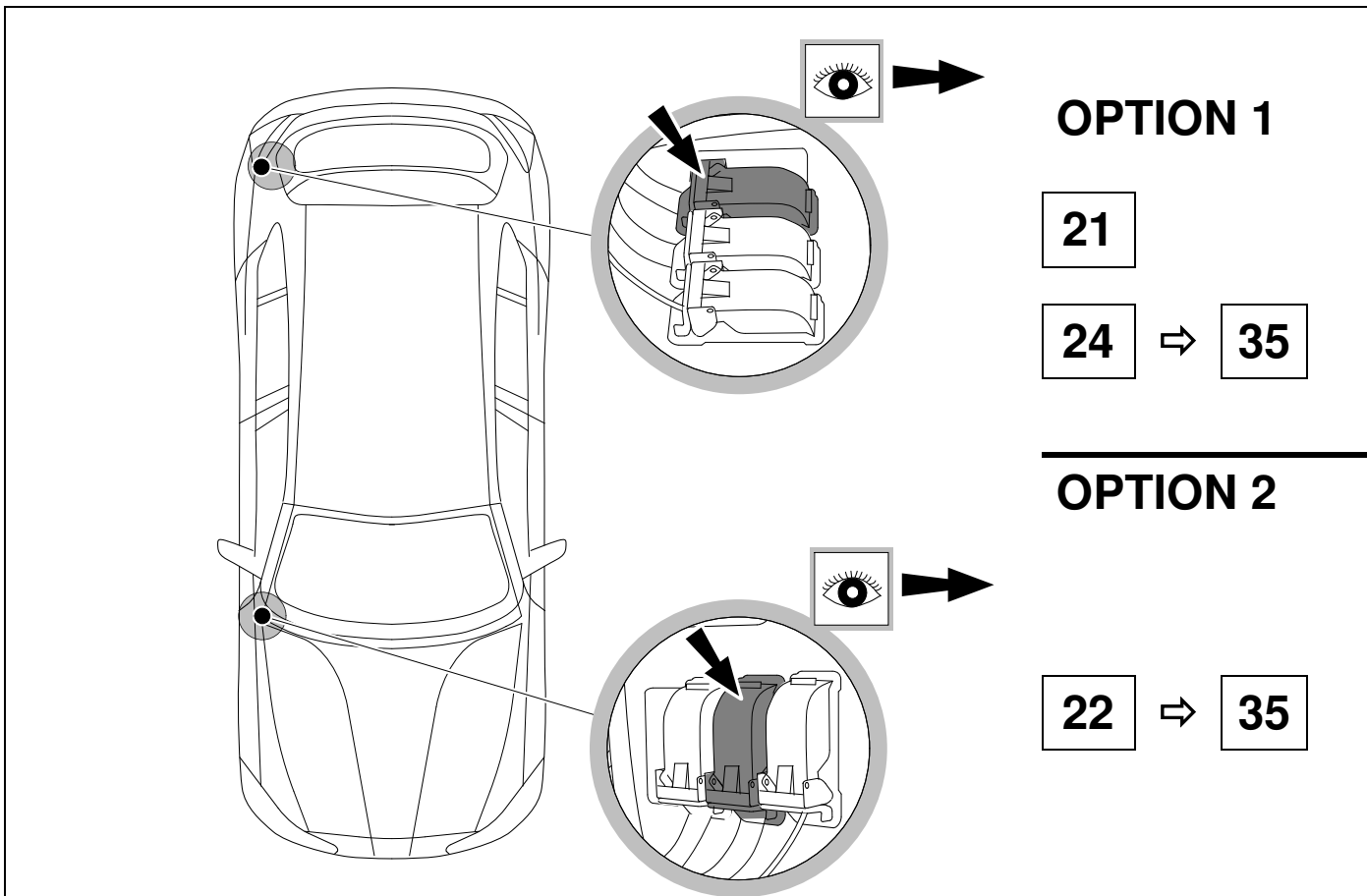

21

OPTION 1



10

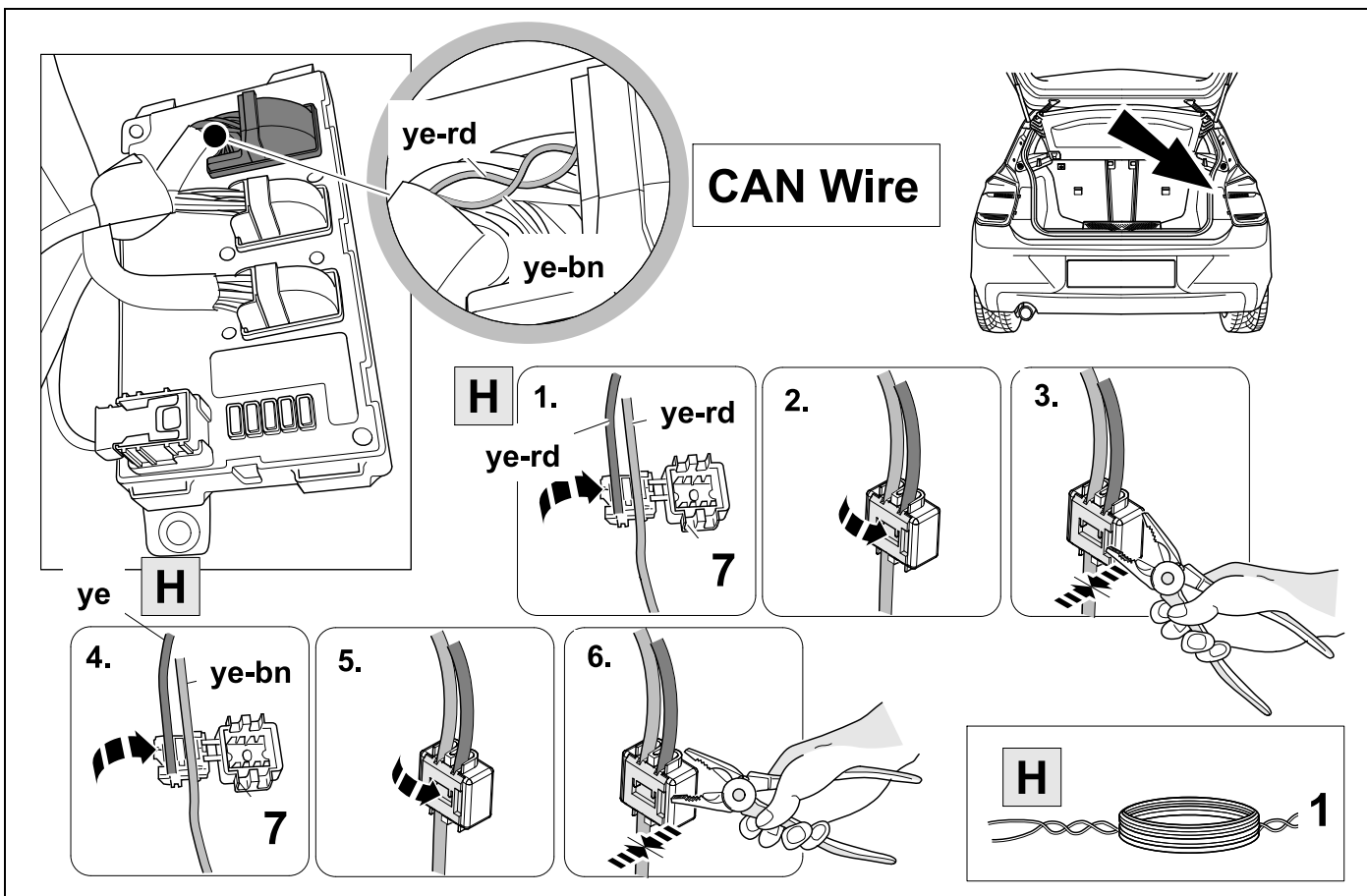

22

OPTION 2



10

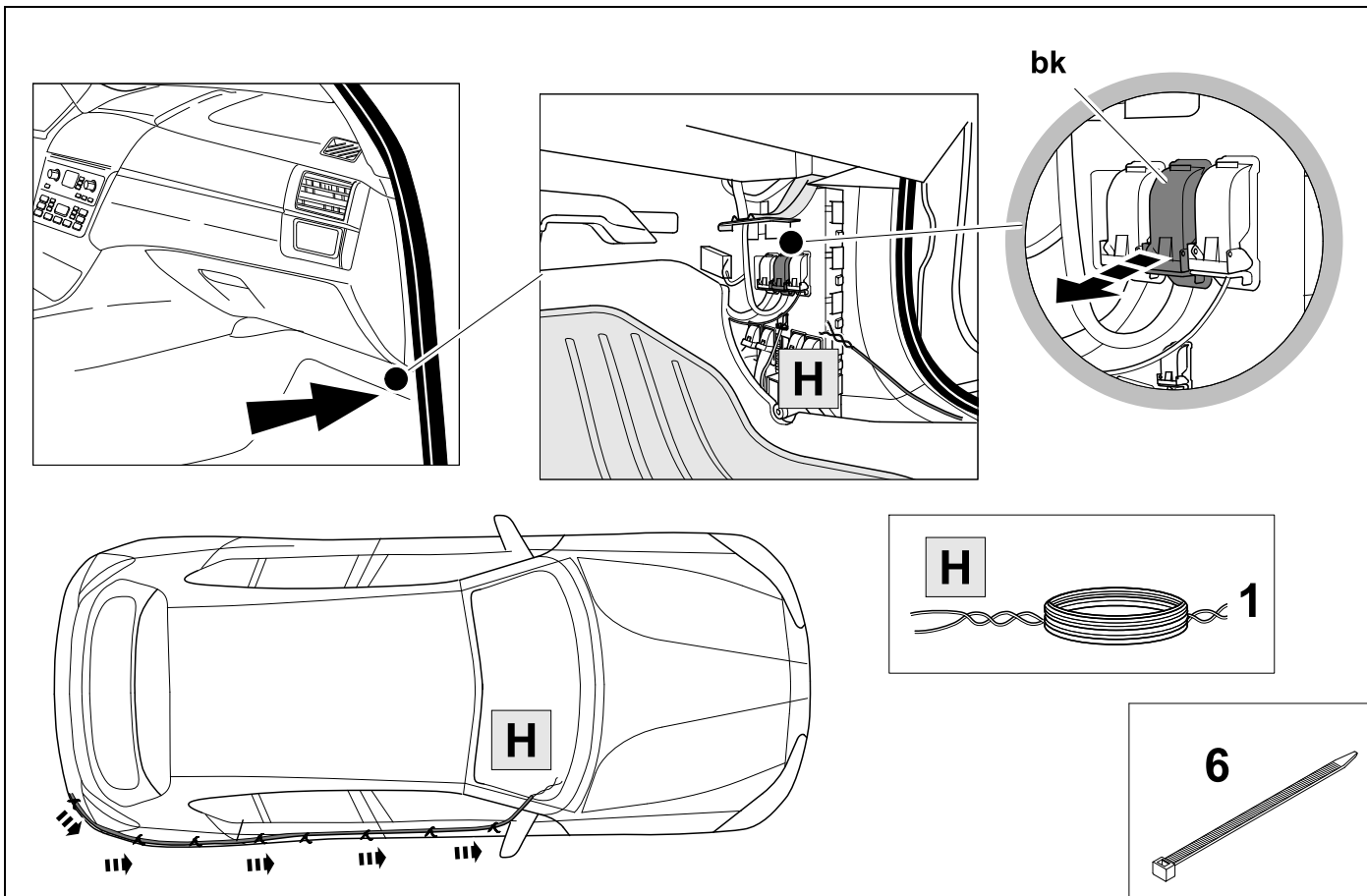

23

OPTION 2



10

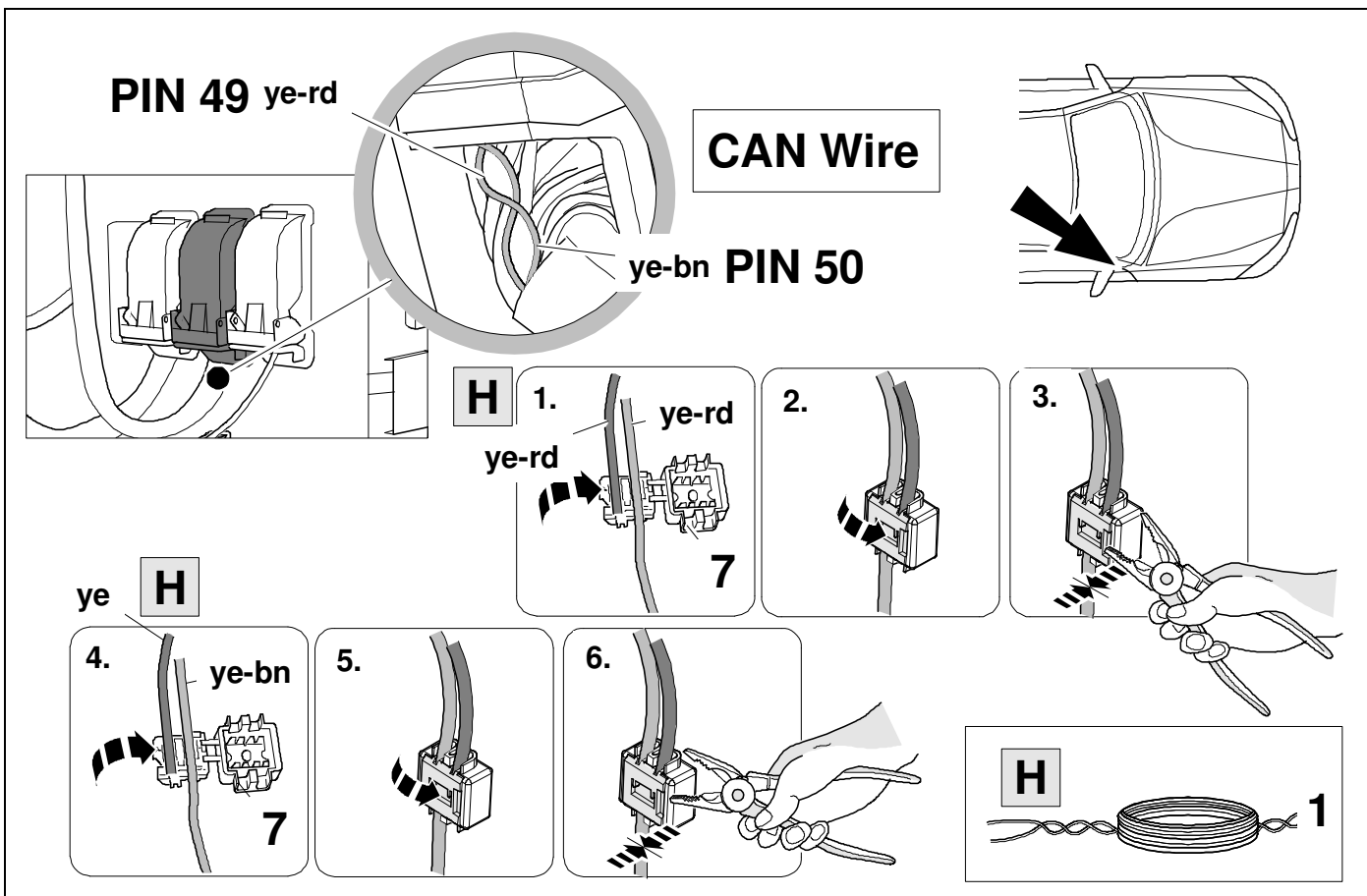

24 OPTIONAL

764159

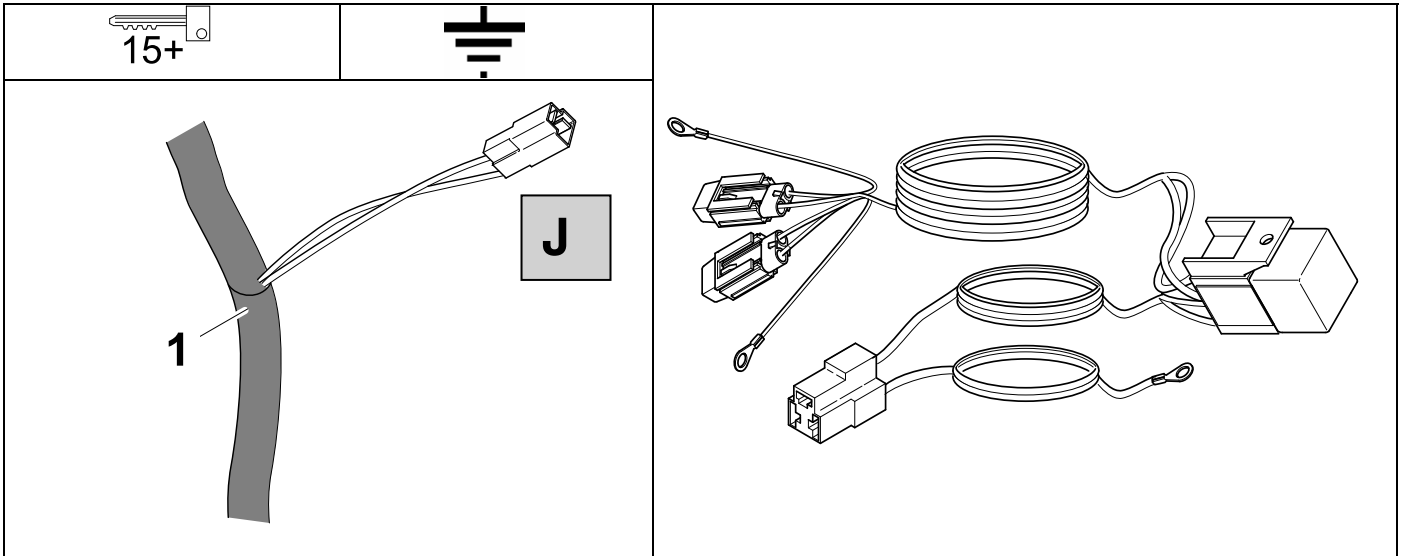

25

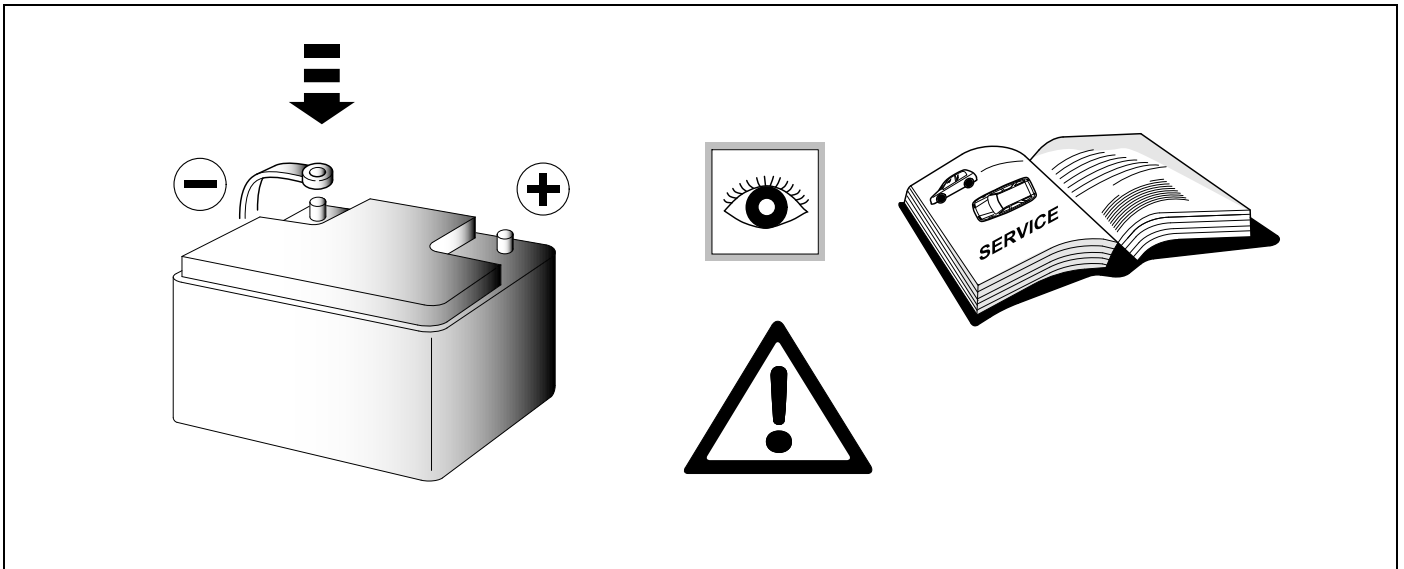

26 CHECK

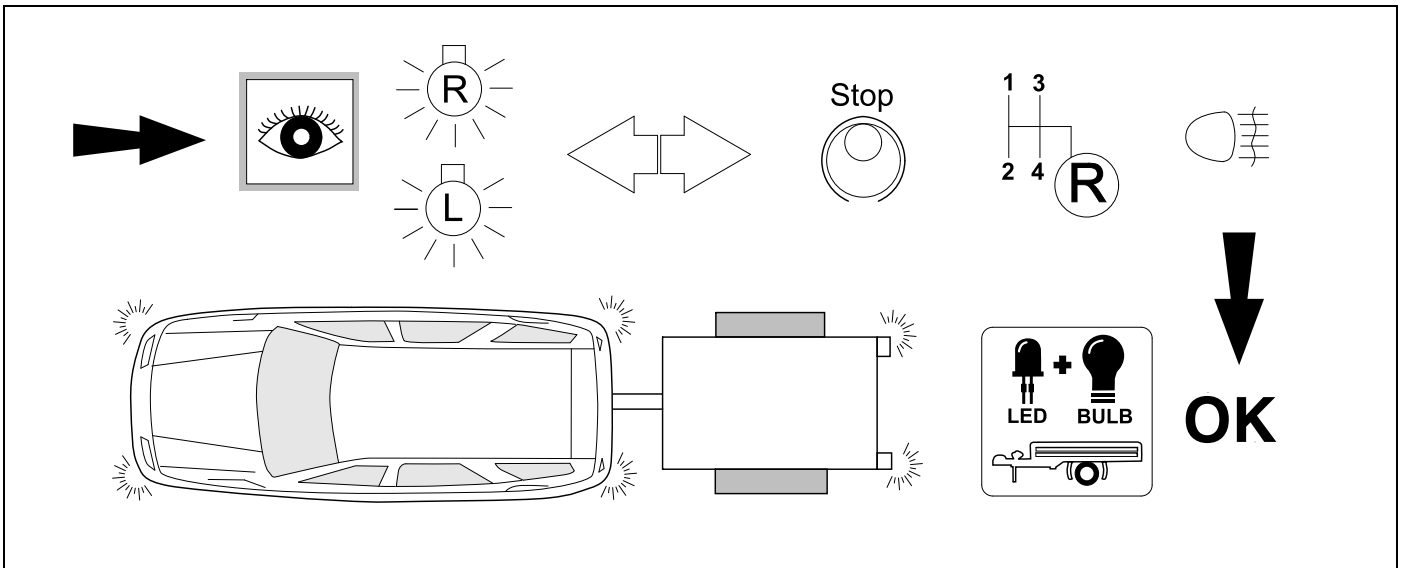

27 OPTIONAL

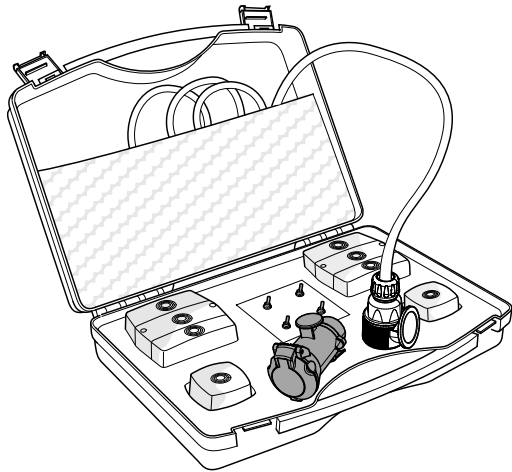

**Trailer Simulator
for 7p and 13p sockets**

765069

28 CHECK

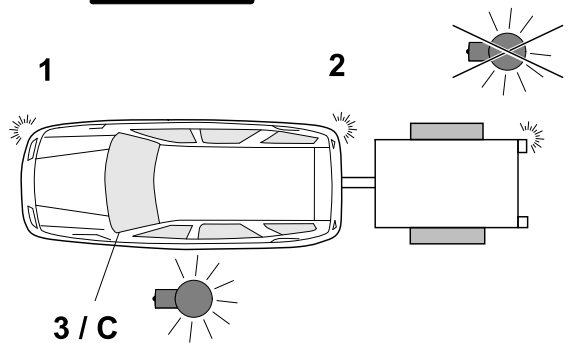
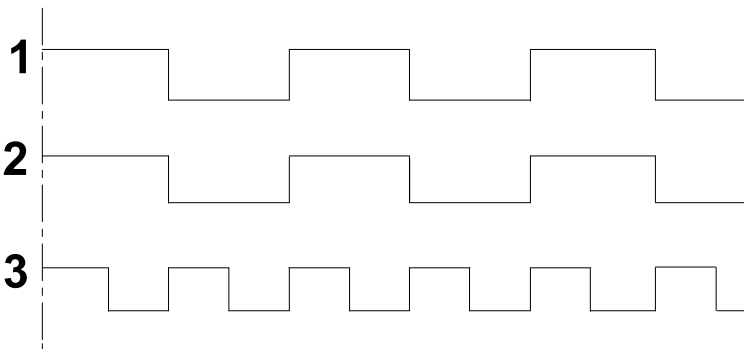

29 CHECK

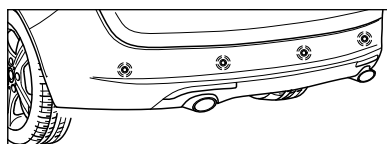
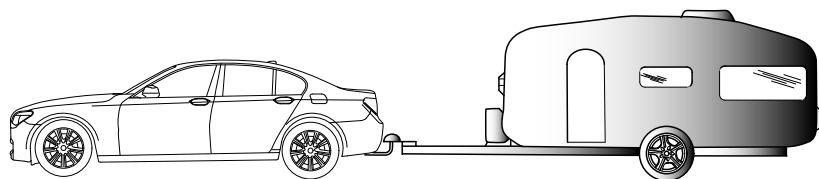
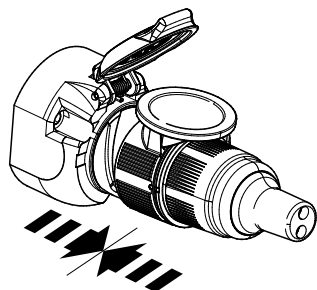

➔ No Coding

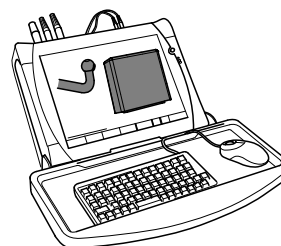
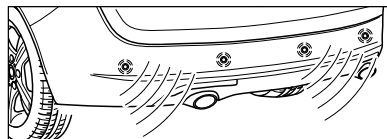

**BMW Service ISTA/P
Initialize Trailer Module**

30 Information Service



16

+

19

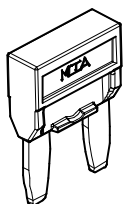

20A

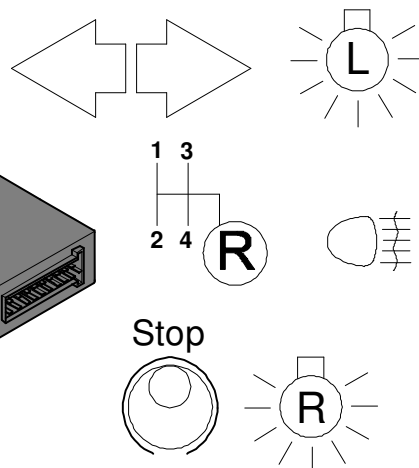
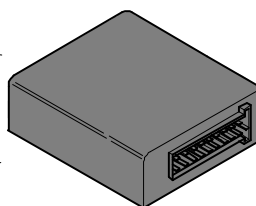
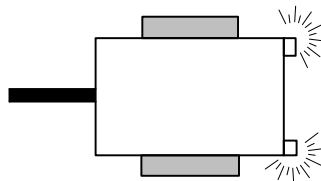

31 Information Service



16

+

19

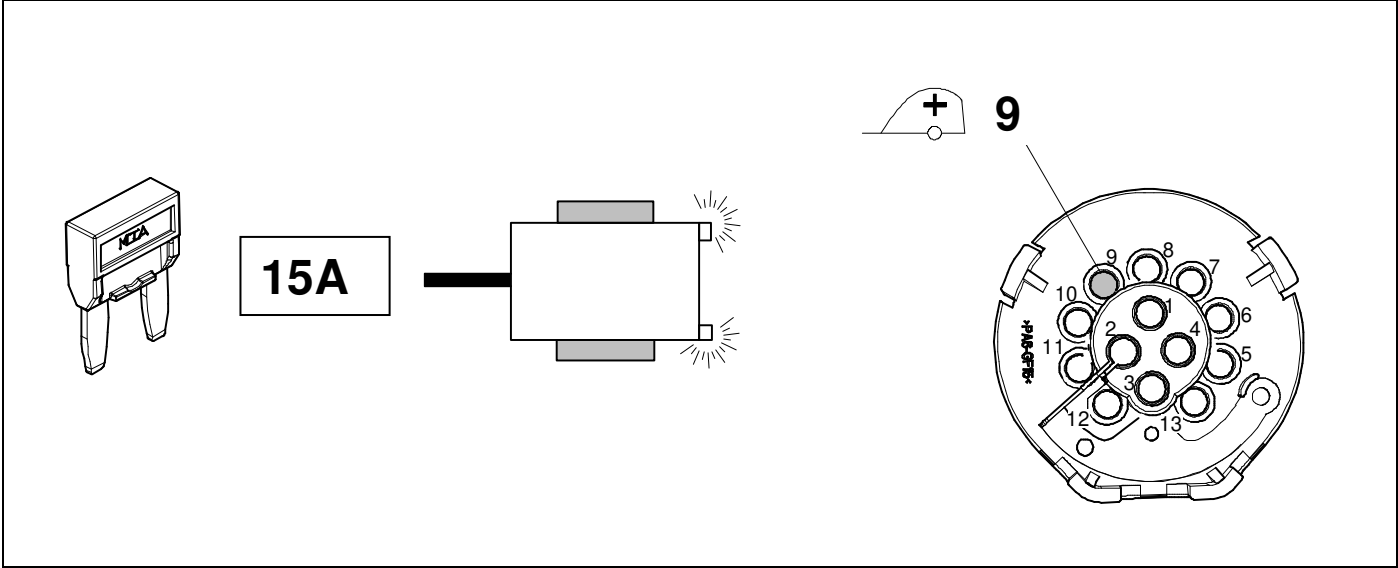

32

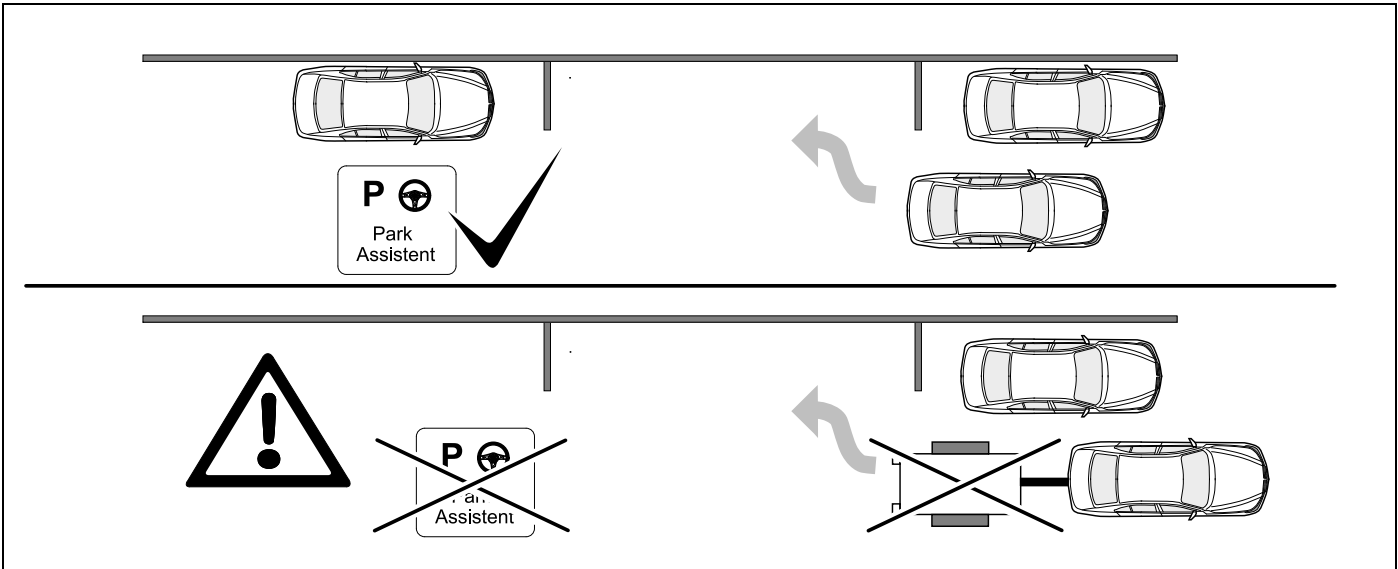

33 OPTIONAL



BRiNK

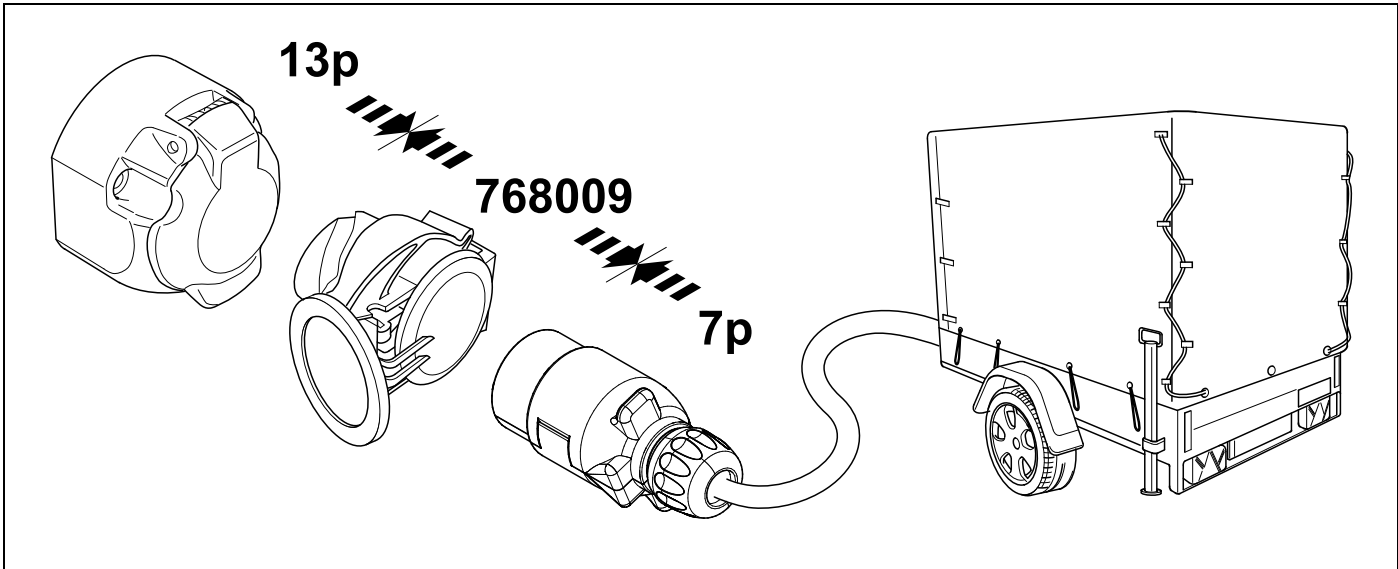

34 PLEASE NOTICE

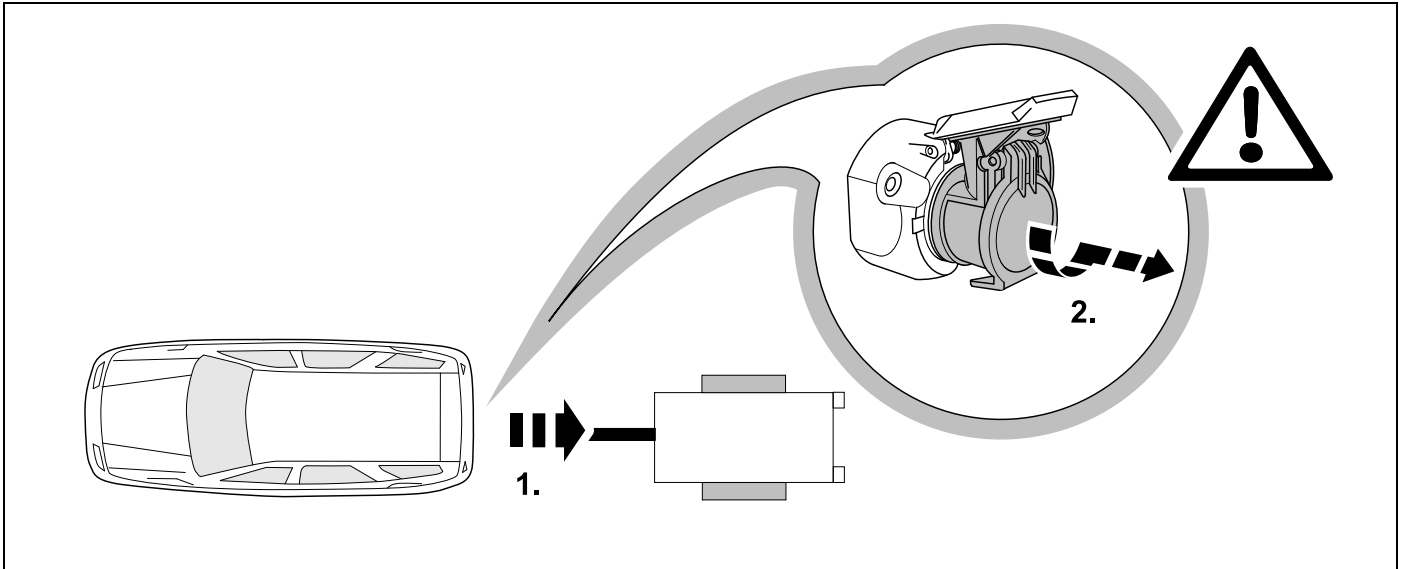

35

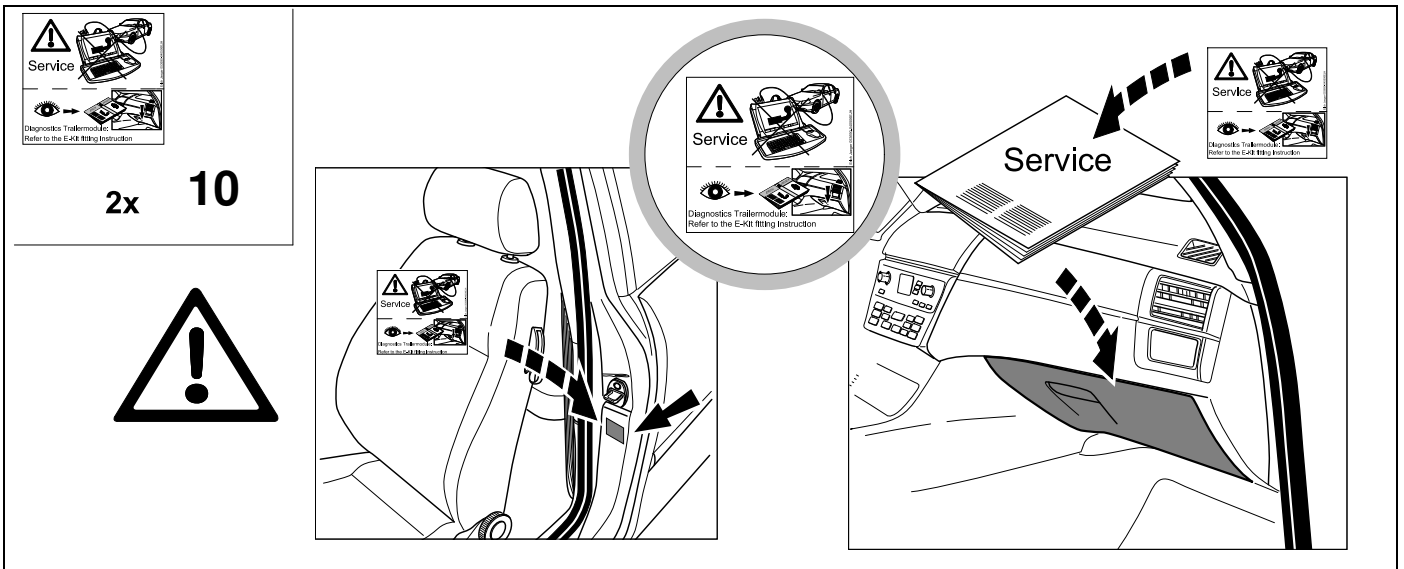

Status LED für Eigendiagnose

Status LED for self-diagnosis

Operation support

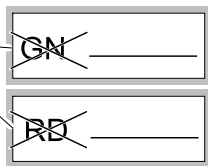
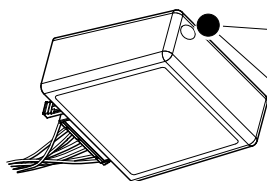
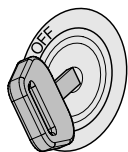

No CAN-Data =



Standby / Sleepmode



Ignition OFF

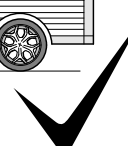
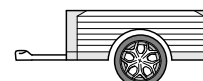
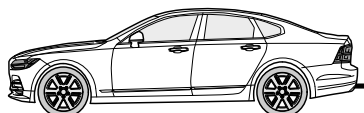
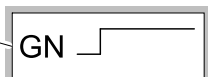
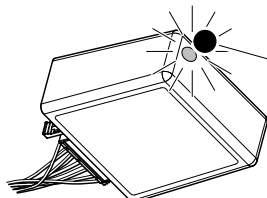

Ignition ON

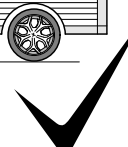
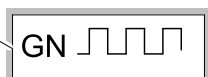
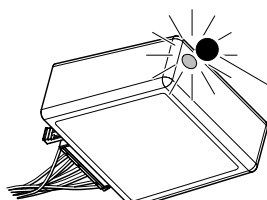
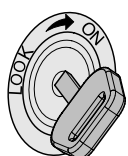

Ignition ON

Failure support

Check CAN-Data Wire

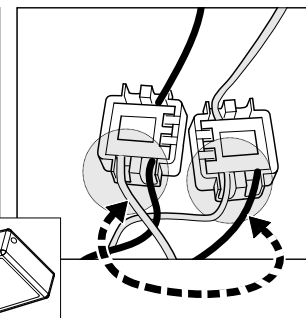
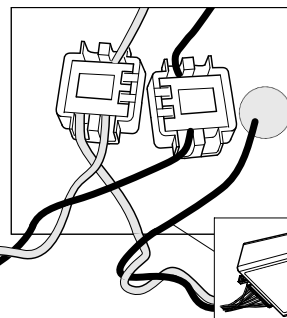
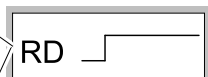
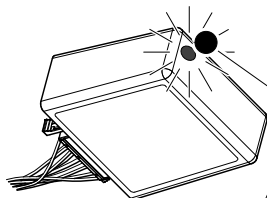

Ignition ON

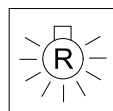
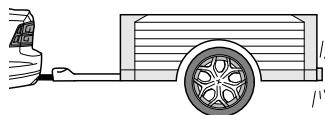

+

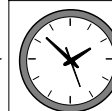
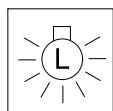

1x max 5 min.

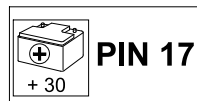
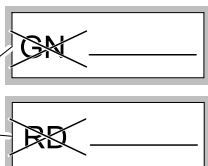
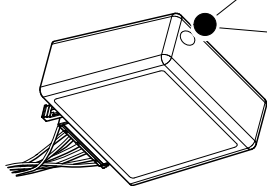

oder / or

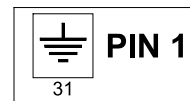

Ignition ON

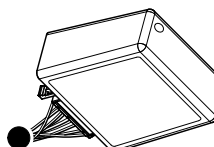
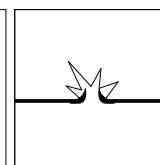
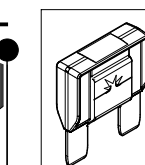
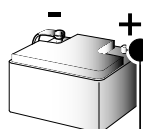



<p>D</p>	<p>Änderungen bezüglich Konstruktion, Ausstattung Farbe sowie Irrtum vorbehalten. Angaben und Abbildungen unverbindlich</p>	<p>PL</p>	<p>Zastrzega się prawo do zmian dot. konstrukcji, wykończenia, kolorystyki oraz pomyłek. Dane i ilustracje niewiążące.</p>
<p>GB</p>	<p>Subject to change in terms of construction, equipment and colour, and may contain errors. The information and illustrations are non-binding.</p>	<p>TR</p>	<p>Tasarım, donanım ve renk bakımından değişiklik yapma hakkı ve hata ve eksiklik mahfuzdur. Veriler ve resimler bağlayıcı değildir.</p>
<p>F</p>	<p>Sous réserve de modifications de la construction, de l'équipement, de la couleur et sous réserve d'erreurs. Les indications et les illustrations sont sans engagement.</p>	<p>H</p>	<p>A szerkezet, a kivitelt és a szín változtatása, valamint a változások joga fenntartva. Az adatok és az ábrák nem kötelező érvényűek.</p>
<p>NL</p>	<p>Wijzigingen met betrekking tot constructie, uitvoering en kleur evenals vergissingen voorbehouden. Gegevens en afbeeldingen zijn niet bindend.</p>	<p>HR</p>	<p>Pravo promjena u svezi konstrukcije, opreme, boje kao i zabune oridžavamo. Podaci i ilustracije su neobavezne.</p>
<p>DK</p>	<p>Ændringer med hensyn til konstruktion, udstyr, farver samt fejl forbeholdes. Oplysninger og illustrationer er uforpligtende.</p>	<p>BUL</p>	<p>Запазени права по отношение на конструкцията, оборудването, цвета и грешки. Данните и изображенията не са обвързващи.</p>
<p>N</p>	<p>Ændringer angående konstruksjon, utstyr, farge og feiltagelse forbeholdes. Oplysninger og illustrasjoner uforbindtlig.</p>	<p>RO</p>	<p>Ne rezervăm dreptul unor modificări ale construcției, dotării, culorii și dreptul la erori Datele indicate și imaginile sunt orientative.</p>
<p>S</p>	<p>Med reservation för ändringar vad det gäller konstruktion, utrustning, färg samt för misstag. Uppgifterna och bilderna är inte bindande.</p>	<p>RU</p>	<p>Права на внесение изменений относительно конструкции, оснащения, окраски, а также на ошибки сохраняются. Данные и иллюстрации имеют примерный характер.</p>
<p>FIN</p>	<p>Pidätämme oikeuden rakennetta, varustusta, väriä koskeviin sekä erehdyksestä johtuviin muutoksiin. Tiedot ja kuvat eivät ole sitovia.</p>	<p>LT</p>	<p>Pasiliekama konstrukcijos, įrangos bei reikmenų, spalvos pakeitimų ir klaidų teisė. Duomenys ir iliustracijos neįpareigojantys.</p>
<p>I</p>	<p>Con riserva di modifiche relative a progettazione, dotazione, colore ed errori. Le indicazioni e figure sono fornite senza impegno.</p>	<p>LV</p>	<p>Tiek paturētas tiesības uz konstrukcijas, iekārtu, krāsu izmaiņām, kā arī kļūdīšanās. Dati un attēli bez saistībām.</p>
<p>E</p>	<p>Reservadas las modificaciones respecto a diseño, equipamiento, color, así como error. Indicaciones y figuras sin compromiso.</p>	<p>EST</p>	<p>Konstruktsiooni, varustuse ja võevi osas muudatused ning eksimine lubatud. Andmed ja joonised on mittesiduvad.</p>
<p>P</p>	<p>Reservamos o direito de alterações relativamente ao desenho, equipamento, cor, bem como de erro. Os dados e as gravuras não implicam compromisso da nossa parte.</p>	<p>SLO</p>	<p>Zadržana pravica do sprememb glede konstrukcije, opreme, barve ter pomote. Podatki in slike so neobvezne.</p>
<p>GR</p>	<p>Διατηρώνουμε κάθε επιφύλαξη ως προς αλλαγές σε σχέση με κατασκευή, εξοπλισμό, διαρρυθμίση, χρωματισμούς και λάθη παραδρομής.</p>	<p>SK</p>	<p>Zmeny, ktoré sa týkajú konštrukcie, vybavenia, farby, ako aj omyly sú vyhradené. Údaje a zobrazenia sú nezáväzné.</p>
<p>CZ</p>	<p>Změny, týkající se konstrukce, vybavení, barvy, jakož i omyly jsou vyhrazeny. Údaje a vyobrazení jsou nezávazné.</p>		