

Fitting instructions

Make: Peugeot

308 SW; 2008->

Type: 4970

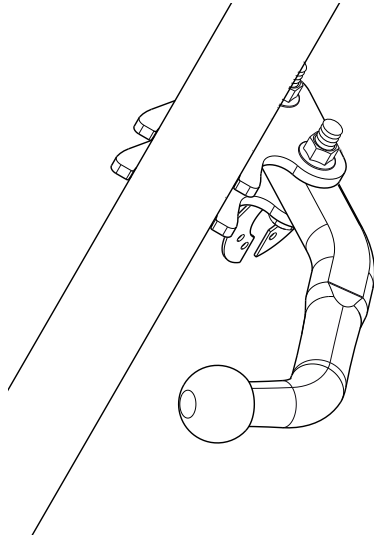

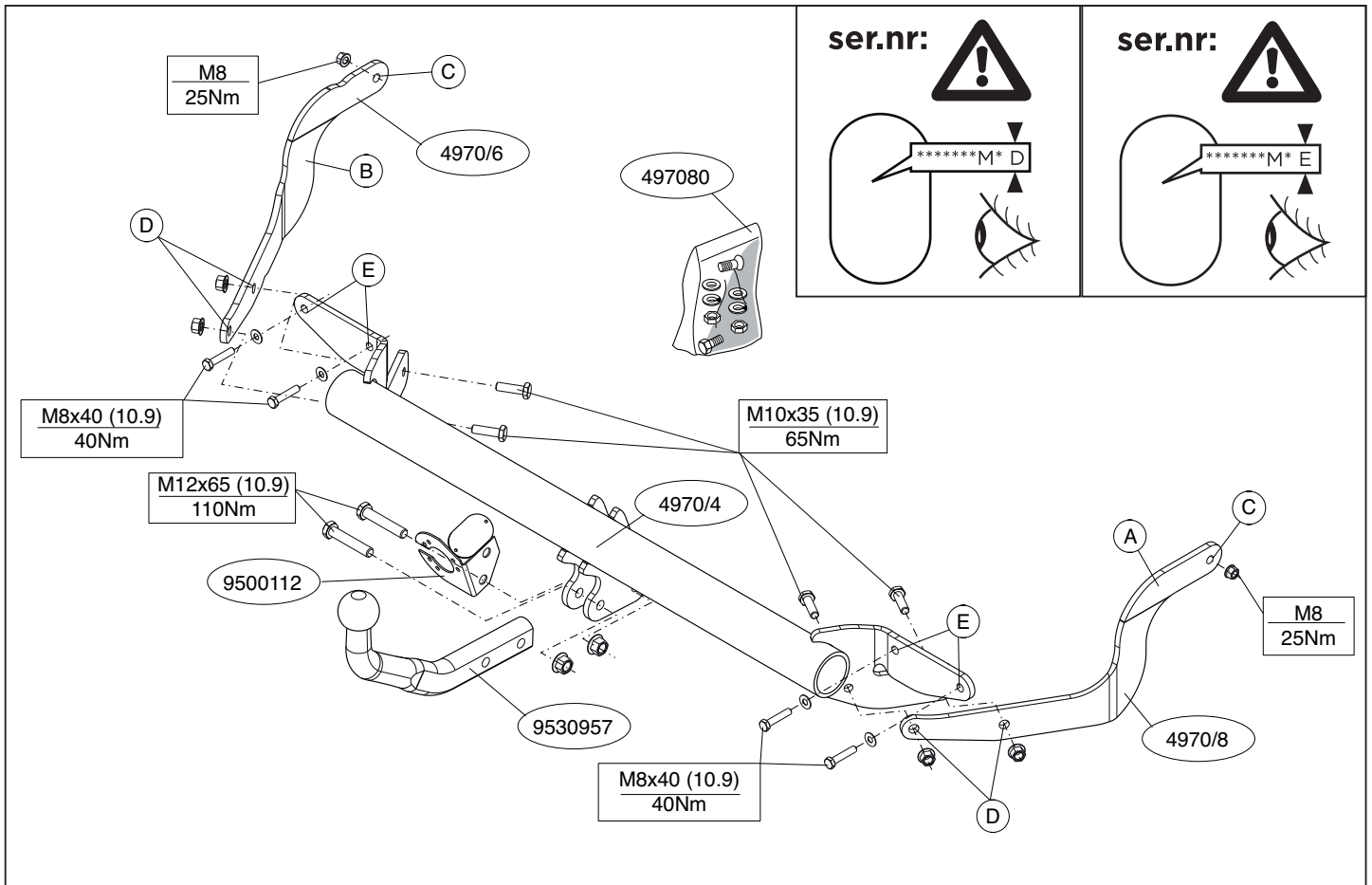

© 497070/07-07-2008/1

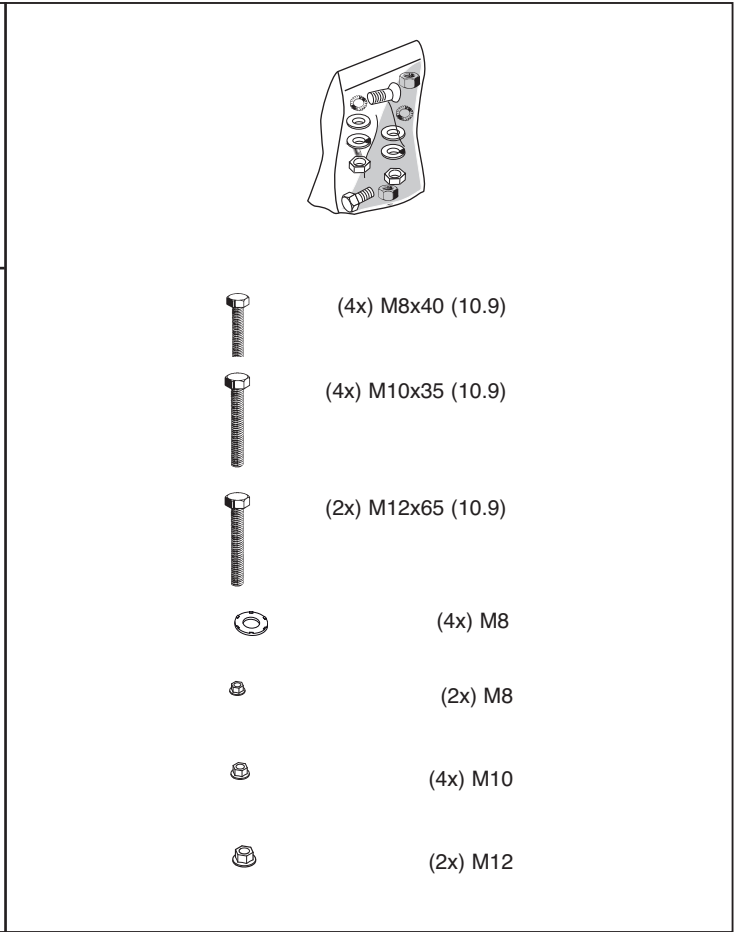
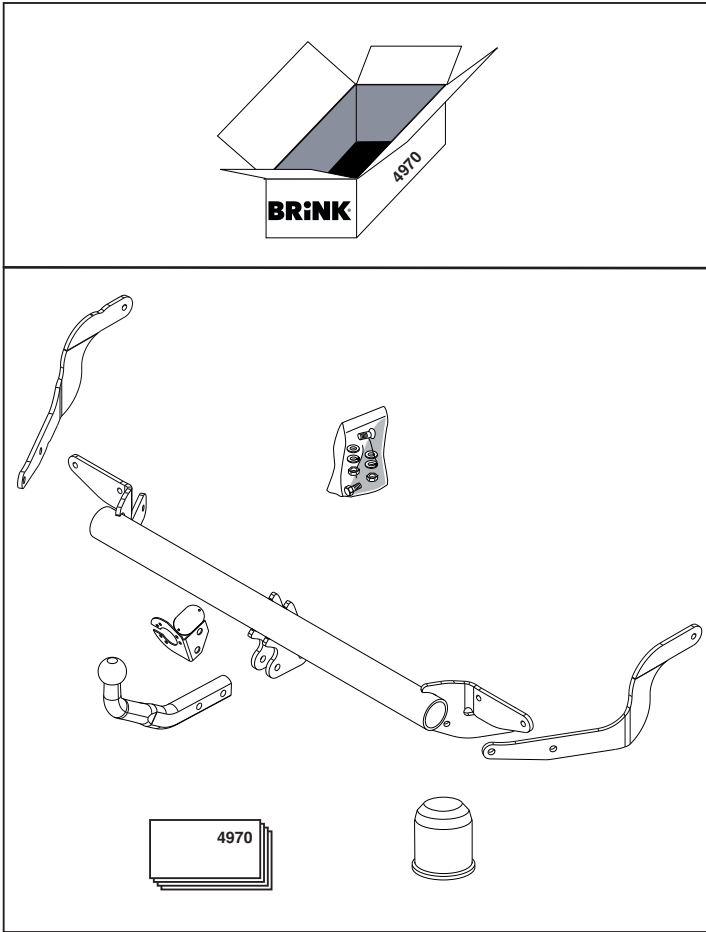

© 497070/07-07-2008/3

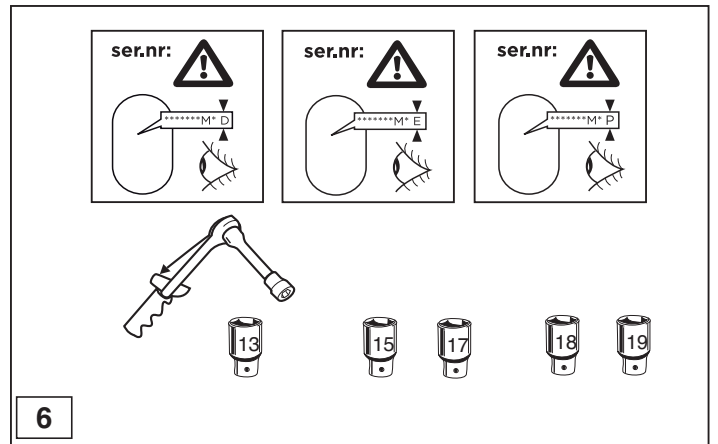
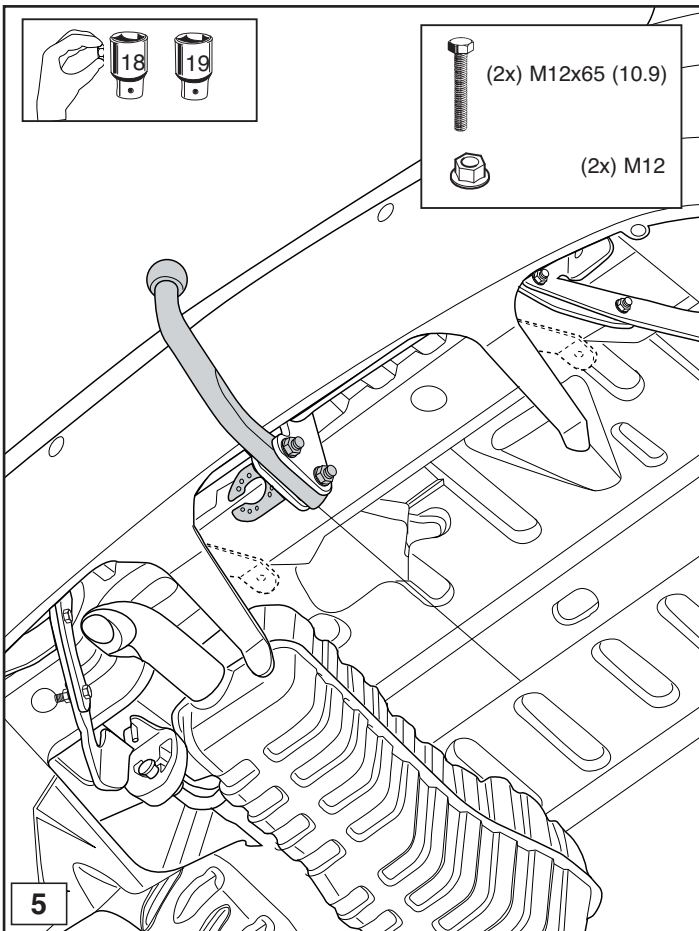

© 497070/07-07-2008/8

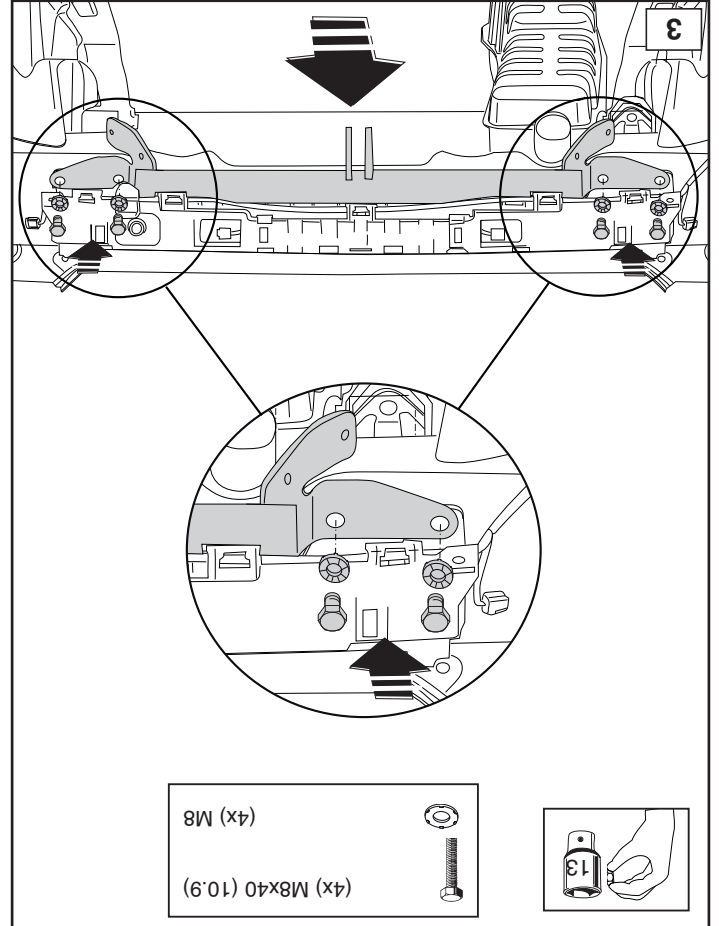
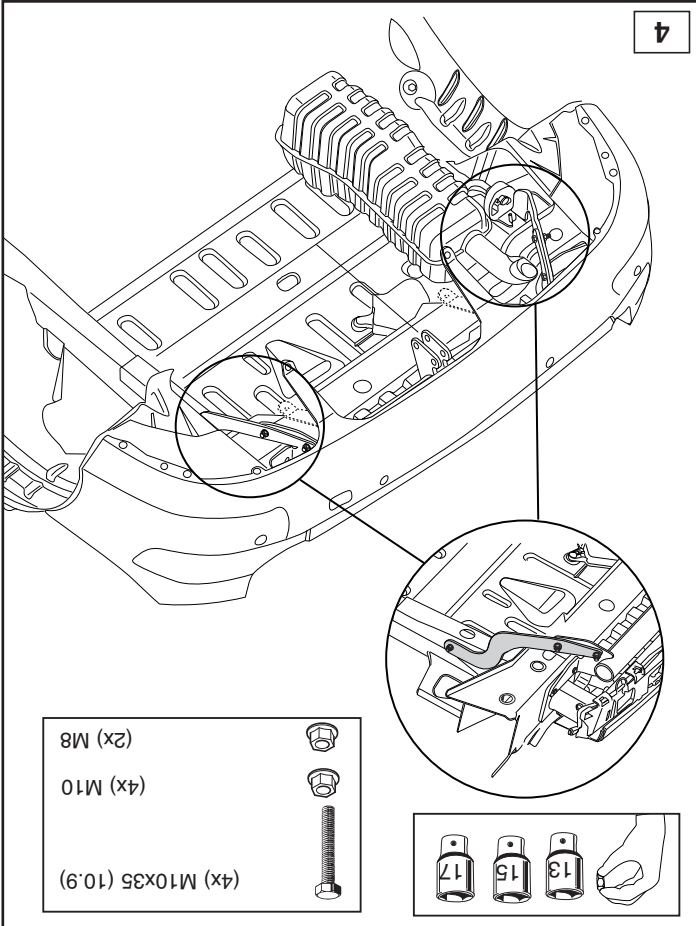
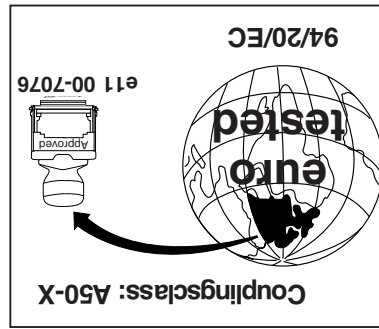
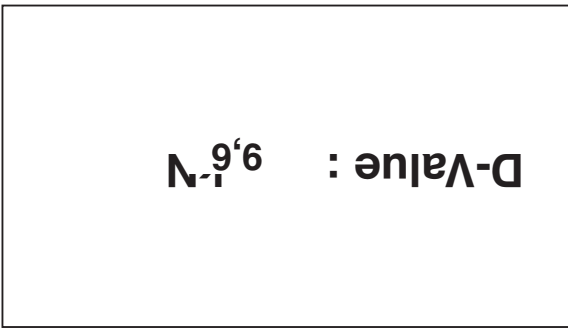
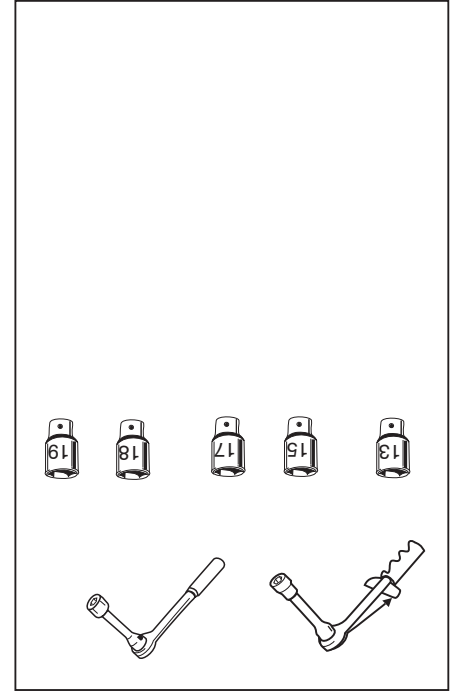
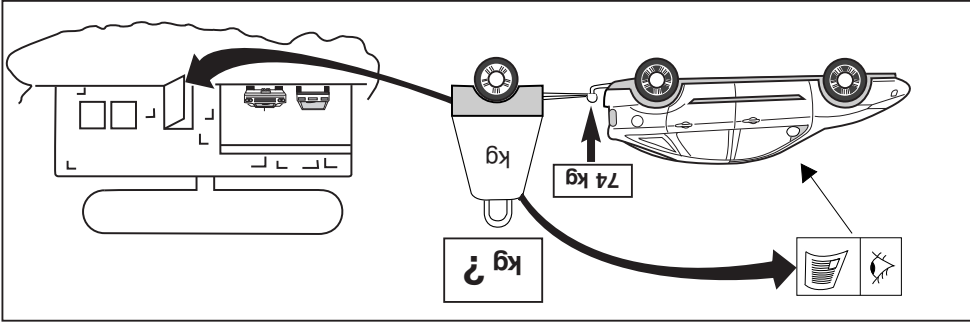
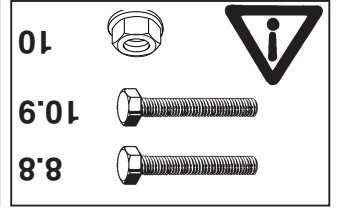
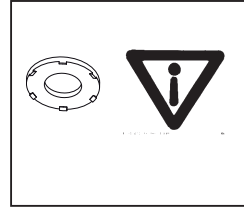
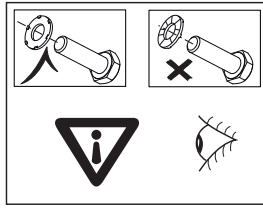



NOTE:

* Should this installation process entail the cutting of the bumper – conformation **MUST** be obtained by the installation engineer of the customer's acceptance prior to completion. Brink Towing Systems do not accept responsibility for any matters arising as a result of this miscommunication.

All measurements are in mm!

HINWEISE:

* Die für das Fahrzeug zugelassene Anhängelast ist den Fahrzeug Unterlagen zu entnehmen. Bei Änderungen des Fahrzeuggewichtes muß die höchstzulässige Anhängelast gegebenenfalls aus dem D-Wert nachgerechnet werden.

Auskunft hierüber kann Ihr Fachhändler oder der TÜV geben.

* Elektrische Anlage gemäß StVZO anbringen.

© 497070/07-07-2008/5

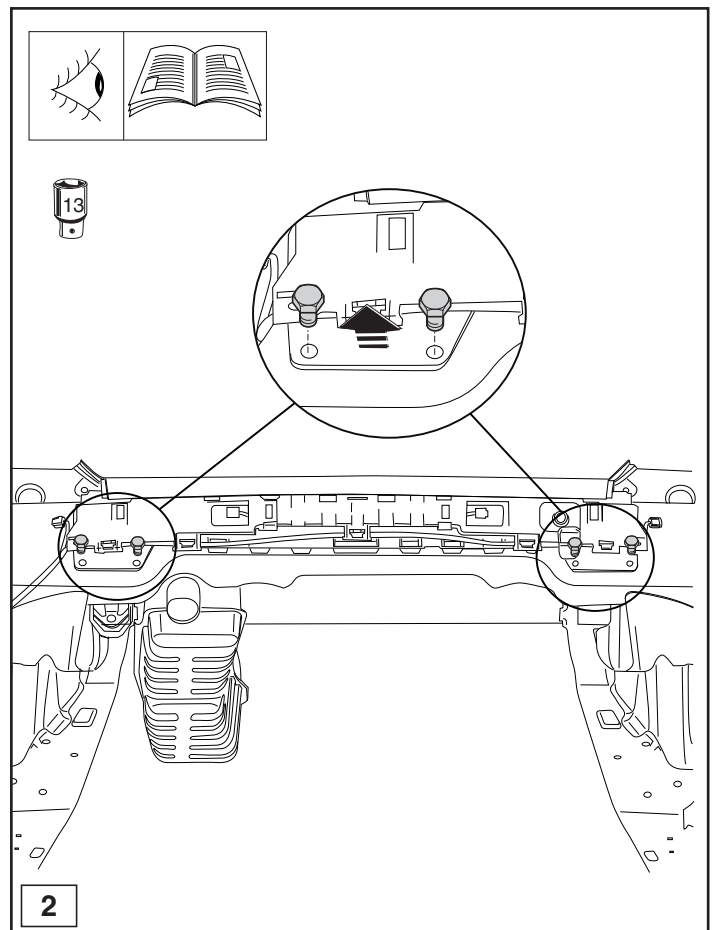
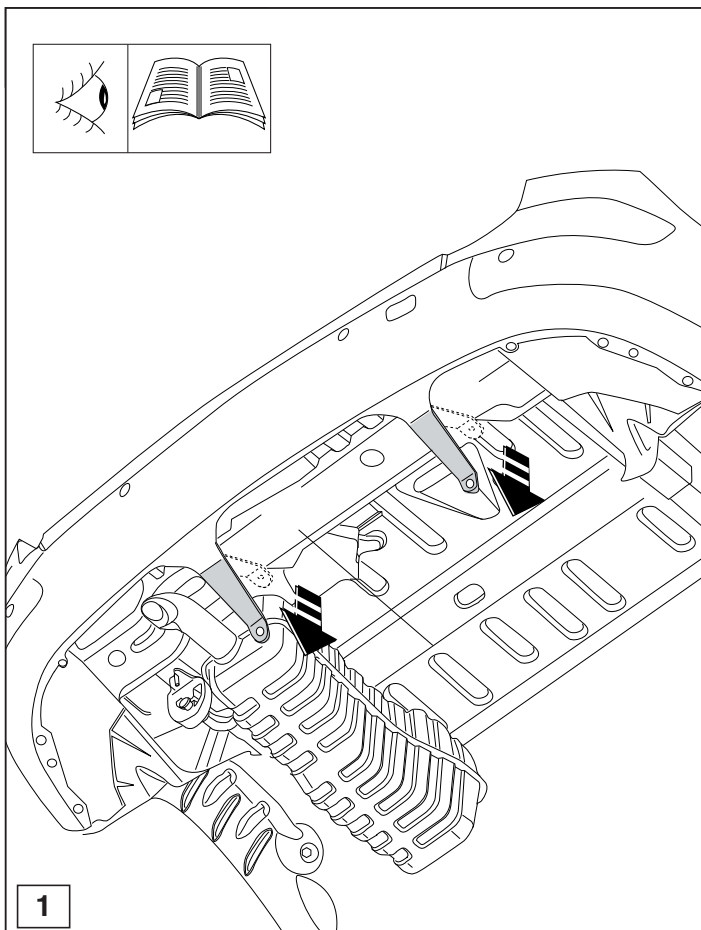

© 497070/07-07-2008/6