

|                                  |            |
|----------------------------------|------------|
| Citroën Berlingo M / XL          | 10/2018 >> |
| Opel Combo E Life / Life XL      | 10/2018 >> |
| Opel Combo E Cargo               | 10/2018 >> |
| Peugeot Partner L1 / L2          | 11/2018 >> |
| Peugeot Rifter L1 / L2           | 10/2018 >> |
| Toyota Proace City L1 / L2       | 12/2019 >> |
| Toyota Proace City Verso L1 / L2 | 12/2019 >> |

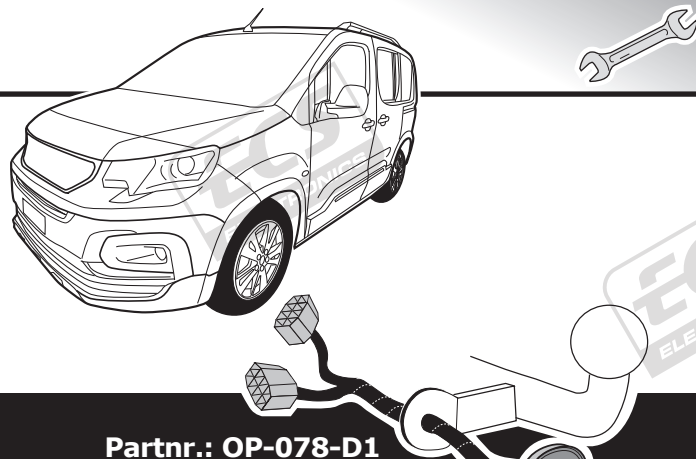

Partnr.: OP-078-D1

**DE** • Einbauanleitung Elektrosatz Anhängervorrichtung mit 13-P Steckdose lt. DIN/ISO Norm 11446. • Wir weisen ausdrücklich darauf hin, dass eine unsachgemäße und nicht in einer Fachwerkstatt durchgeführte Montage einen Verzicht auf Entschädigung jeglicher Art insbesondere bezüglich des Produkthaftpflichtrechts zur Folge hat. • Technische Änderungen vorbehalten. • Widerstand nur gemäß der Tabelle auf dem Anhänger verwenden. • Achtung! Bitte lesen Sie vorab diese Anleitung, nehmen Sie diese zur Kenntnis und verweisen Sie Ihren Kunden auf das Bedienbuch bezgl. der eventuell zu treffenden Maßnahmen zum ziehen eines Anhängers. • Bei Funktionsproblemen ist die Fehlersuche auf ca. 0,5 Stunden zu begrenzen, kontaktieren Sie die ECS Technical Support: ts@ecs-electronics.nl / 00800 22552327

**FR** • Instructions de montage du faisceau électrique pour crochet d'attelage conforme à la norme DIN/ISO 11446 prise 13-P. • Il est expressément prévu qu' on ne saurait se prévaloir d'un quelconque préjudice contractuel ou réhibitoire si le montage avait été fait en dépit des dites instructions ou dans un garage ne disposant pas des équipements adéquats. • Sous réserve de modifications techniques. • Ne excédez pas la charge maximale, indiquée dans le tableau. • Attention! Avant de commencer le branchement, on vous prie de prendre compte des connexions à faire dans la notice, ainsi que communiquer directement à votre client les mesures à prendre pour tirer une remorque. • S'il y a des problèmes de fonctionnement, limiter la recherche de défauts à env. 30 minutes et contacter ECS l'Aide en ligne: ts@ecs-electronics.nl / 00800 22 55 23 27.

**NL** • Montage-handleiding elektrokabelset voor trekhaak met 13-P contactdoos vlg. DIN/ISO norm 11446. • Wij wijzen er met nadruk op, dat ondeskundige en niet door een vakkundige werkplaats uitgevoerde montage tot gevolg heeft dat daardoor ieder recht op schadevergoeding, ook op wettelijke aansprakelijkheid inzake producten, vervalt. • Technische wijzigingen voorbehouden. • Gebruik alleen belasting volgens aansluittabel op het getrokken voertuig. • Opgelet! Wij verzoeken U dringend vooraf deze instructie door te nemen, hiervan kennis te nemen en uw cliënt te verwijzen naar het instructieboekje betreffende de eventueel te nemen maatregelen voor het trekken van een aanhangwagen. • Bij werkingsproblemen moet de foutencontrole tot ca. 0,5 uur beperkt worden, neem contact op met de ECS Technical Support: ts@ecs-electronics.nl / 00800 22 55 23 27.

**GB** • Fitting instructions electric wiring kit tow bar with 13-P socket up to DIN/ISO Norm 11446. • We would expressly point out that assembly not carried out properly by a competent installer will result in cancellation of any right to damage compensation, in particular those arising by virtue of the product liability act. • Contents of these kits and their fitting manuals are subject to alteration without notice, please ensure that these instructions are read and fully understood before commencing installation. • Do not overload circuits; the maximum loads per connection are detailed in this manual. • Attention! Before installation, please read this manual carefully and inform your customer to consult the vehicle owners manual to check for any vehicle modifications required before towing. • In the event of functional problems, troubleshooting must be limited to about 0.5 hours, contact the ECS Technical Support: ts@ecs-electronics.nl / 00800 22 55 23 27.

**ES** • Instrucciones de montaje de kit eléctrico para enganche de remolque con caja de conexiones 13-P según norma DIN/ISO 11446. • El montaje inapropiado y efectuado por personal no cualificado originará la pérdida de todo derecho a indemnización o la expiración de toda responsabilidad civil con respecto al producto. • Nos reservamos el derecho a efectuar modificaciones técnicas. • Utilice sólo cargas de acuerdo a la tabla de conexión del vehículo remolcado. • Atención: lea atentamente este manual antes de la instalación e informe al cliente que debe consultar el manual de usuario del vehículo para conocer cualquier modificación realizada. • En caso de tener problemas con su funcionamiento, la búsqueda de errores está limitada a aprox. 0,5 horas, por lo que le recomendamos ponerse en contacto con el servicio de atención telefónica: ts@ecs-electronics.nl / 00800 22 55 23 27.

**IT** • Istruzioni di montaggio di set di cavi elettrici per gancio da traino con zoccolo a 13-P conforme alla norma DIN/ISO 11446. • Sottolineiamo espressamente che un montaggio inadeguato ed eseguito da un'officina non specializzata ha come conseguenza il decadere di qualsiasi diritto al risarcimento danni, nonché alla responsabilità legale relativa ai prodotti. • Ci si riserva il diritto di apportare modifiche tecniche. • Utilizzare esclusivamente un carico conforme alla tabella degli allacci relativa al veicolo in questione. • Attenzione! Vi invitiamo a leggere attentamente questo manuale e a invitare a vostra volta i clienti a leggere il manuale del conducente sulle eventuali misure da prendere per l'attacco di un rimorchio. • In caso di problemi di funzionamento, la ricerca di errori dovrebbe essere limitata a circa 0,5 ore. Contattare il centralino di assistenza per i fasci di cavi: ts@ecs-electronics.nl / 00800 22 55 23 27.

**SE** • Monteringsanvisningar elkabelsats för dragkrok med 13-P kontaktlåsa enligt DIN/ISO norm 11446. • Vi påpekar med eftertryck att all rätt till skadeersättning och all laglig ansvarighet förfaller om monteringen inte har utförts på rätt sätt och av en professionell verkstad. • Tekniska ändringar förbehålles. • Använd endast belastning enligt anslutningstabellen på det dragna fordonet. • Varning! Innan installation, läs den här handboken noga och informera din kund om att låsa fordonets användarhandbok för att undersöka vilka eventuella ändringar som behöver göras på fordonet. • Vid funtionsproblem ska felsökningen begränsas till ca 0,5 timme, kontakta reservdels-helpline ts@ecs-electronics.nl / 00800 22 55 23 27.

**CZ** • Montážní pokyny: souprava pro elektrické propojení tažné tyče s 13-P zásuvkou do normy DIN/ISO 11446. • Výslovně zdůrazňujeme, že jakákoli montáž, která není provedená ve specializované dílně, má za následek odvolání nároků na kompenzaci jakéhokoli druhu, obzvláště vyplývajících ze zákona o odpovědnosti za způsobení škody. • Změny mohou být provedeny bez oznámení. • Používejte pouze při maximálním nabití podle tabulky na tažném vozidle. • Upozornění! Prosíme, abyste si nejdříve přečetli tyto instrukce, seznámili se s nimi a odkázali své zákazníky na příručku týkající se případných opatření, která musí být přijata pro tažení přívěsu. • Při problémech funkčnosti je třeba vyhledávání chyb omezit na cca 0,5 hodiny, kontaktujte ECS Technical Support: ts@ecs-electronics.nl / 00800 22 55 23 27.

**DK** • Monteringsvejledninger for det elektriske ledningsføringssæt for trækstang med 13-P stikdåse, DIN/ISO, norm 11446. • Vi ønsker at gøre udtrykkeligt opmærksom på atforkert samling, der ikke er udført af et specialiseret værksted, resulterer i bortfaldelse af kompenseringsskrav af alle slags, i særdeles krav der måtte opstå omkring det lovligtige ansvar. • Kan ændres uden varsel. • Brug kun den maksimale belastning, i overensstemmelse med forbindelsestabelen for bugserede køretøjer. • OBS! For installation skal denne vejledning læses omhyggeligt og din kunde skal informeres om at kigge i køretøjets håndbog for at kontrollere om der skal laves eventuelle ændringer på køretøjet inden bugsering. • Ved funktionsproblemer skal fejlsøgningen begrænses til ca. 0,5 time, kontakt ECS Technical Support: ts@ecs-electronics.nl / 00800 22 55 23 27.

**FI** • Ohjeet vetokoukun sähkökaapelisarjan asentamiseen, jossa on DIN/ISO 11446 mukainen 13-P liitin. • Korostamme, että kaikki oikeudet vahinkokorvaukseen kuten myös valmistajan laillinen vastuu raukeavat, mikäli asennusta ei ole toteutettu oikealla tavalla eikä ammattitaitoisen asiantuntijan toimesta. • Oikeus teknisiin muutoksiin ilman erillistä huomautusta pidätetään. • Huomio! Lue tämä käyttöoppas huolellisesti ennen asennusta ja tiedota asiakkaita tarkistamaan kaikki ajoneuvon muutoksen ajoneuvon omistajan käyttöoppaas ennen hinausta. • Kuormita työvirtapiiriä ainoastaan hinattavan ajoneuvon kytkentäkaavin mukaisesti. • Virhehaku on rajoitettava toiminto-ongelmien esiintyessä noin 0,5 tuntiin, ota yhteys ECS Technical Support: ts@ecs-electronics.nl / 00800 22 55 23 27.

**GR** • Οδηγίες συναρμολόγησης ηλεκτρικού σετ καλωδίων μπάρας ρυμούλκησης με υποδοχή 13-P μέτρη DIN/ISO Κανόνας 11446. • Επισημαίνουμε κατηγορηματικά ότι οποιαδήποτε ασφαλή συναρμολόγηση, η οποία δεν έχει πραγματοποιηθεί ειδικό εργαστήριο θα οδηγήσει σε αποποίηση των αξιώσεων επιβολής αποζημιώσεων οποιοδήποτε είδους, ειδικά όσα προκύπτουν από το νόμο ευθύνης προϊόντων. • Μπορεί να τροποποιηθεί χωρίς προηγούμενη ειδοποίηση. • Χρησιμοποιείτε μόνο μέγιστο ηλεκτρικό φορτίο σύμφωνα με τον πίνακα σύνδεσης στο ρυμούλκούμενο όχημα. • Προσοχή! Πριν την εγκατάσταση, διαβάστε το εγχειρίδιο αυτό προσεκτικά και ενημερώστε τον πελάτη σας να συμβουλευτεί το εγχειρίδιο ιδιοκτητών οχήματος ώστε να ελεγχθεί τυχόν τροποποιήσεις που απαιτούνται στο όχημα πριν τη ρυμούλκηση. • Σε περίπτωση προβλημάτων λειτουργίας να περιοριστεί η αναζήτηση σφαλμάτων σε περί. 0,5 δευτ., επικοινωνήστε με τη γραμμή υποστήριξης ECS Technical Support: ts@ecs-electronics.nl / 00800 22 55 23 27.

**NO** • Monteringsanviser elkabelsett for trekkrok med 13-P koblingsboks ifølge DIN/ISO norm 11446. • Vi påpeker ettertrykkelig at all rett til skadeerstatning og rettslig ansvar forfaller dersom monteringen ikke er blitt utført på riktig måte og av et profesjonelt verksted. • Tekniske endringer forbeholdes. • Overskrid ikke grensene anviset i tilkoblingstabellen på tilhengeren eller det tilkoblede kjøretøyet. • OBS! Les denne bruksanvisningen nøye før installasjon. Be kunden om å rådføre seg med brukerhåndboken for kjøretøyeiere for å sjekke om kjøretøyet må modifiseres før tauing. • Ved funksjonsproblemer må feilsøket begrenses til ca. 0,5 timer, kontakt ECS Technical Support: ts@ecs-electronics.nl / 00800 22 55 23 27.

**PL** • Instrukcje montażu zestawu okablowania elektrycznego dysza holowniczego z 13-P stykowym gniazdem DIN/ISO 11446. • Chcielibyśmy wyraźnie zaznaczyć, iż wszelki nieprawidłowy montaż, który nie jest wykonywany w specjalistycznym warsztacie posiada z sobą utratę możliwości dochodzenia wszelkiego typu roszczeń, w szczególności tych wynikających z odpowiedzialności producenta za swój produkt. • Podlega zmianom bez powiadomienia. • Używać tylko takiego maksymalnego obciążenia które wynika z tabliczki połączeń holowanego pojazdu. • Uwaga! Przed zainstalowaniem należy dokładnie przeczytać tę instrukcję i poinformować klienta o konieczności sprawdzenia w instrukcji posiadacza pojazdu w celu sprawdzenia przed holowaniem, czy nie wprowadzono do pojazdu jakichkolwiek zmian. • W przypadku problemów ograniczyć wyszukiwanie błędów do ok. 0,5 godziny, skontaktować się z linią serwisową ts@ecs-electronics.nl / 00800 22 55 23 27.

Einzelteilliste

Liste de pièces

Onderdelenlijst

Part list

Lista de componentes

Elenco componenti

Dellista

Seznam dílů

Del-liste

Osaluettelo

Κατάλογος εξαρτημάτων

Delliste

Lista części

DE

FR

NL

GB

ES

IT

SE

CZ

DK

FI

GR

NO

PL

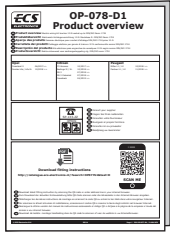
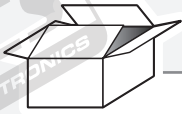

M

+30

+15

Additional Power Supply SP-133-ZZ

\*

X

U1

L1

G

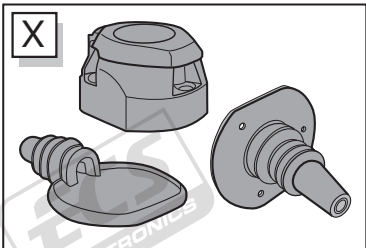

X

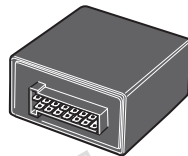

M

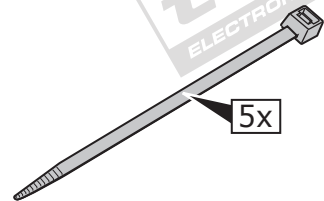

5x

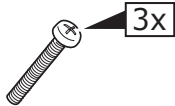

3x



3x



3x



1x

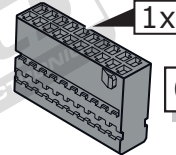

1x

C

U3



U2

U5



U4

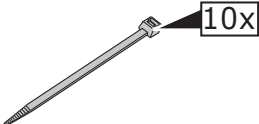

10x



1x

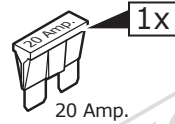

1x

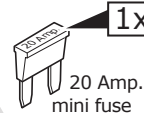

1x

20 Amp. mini fuse

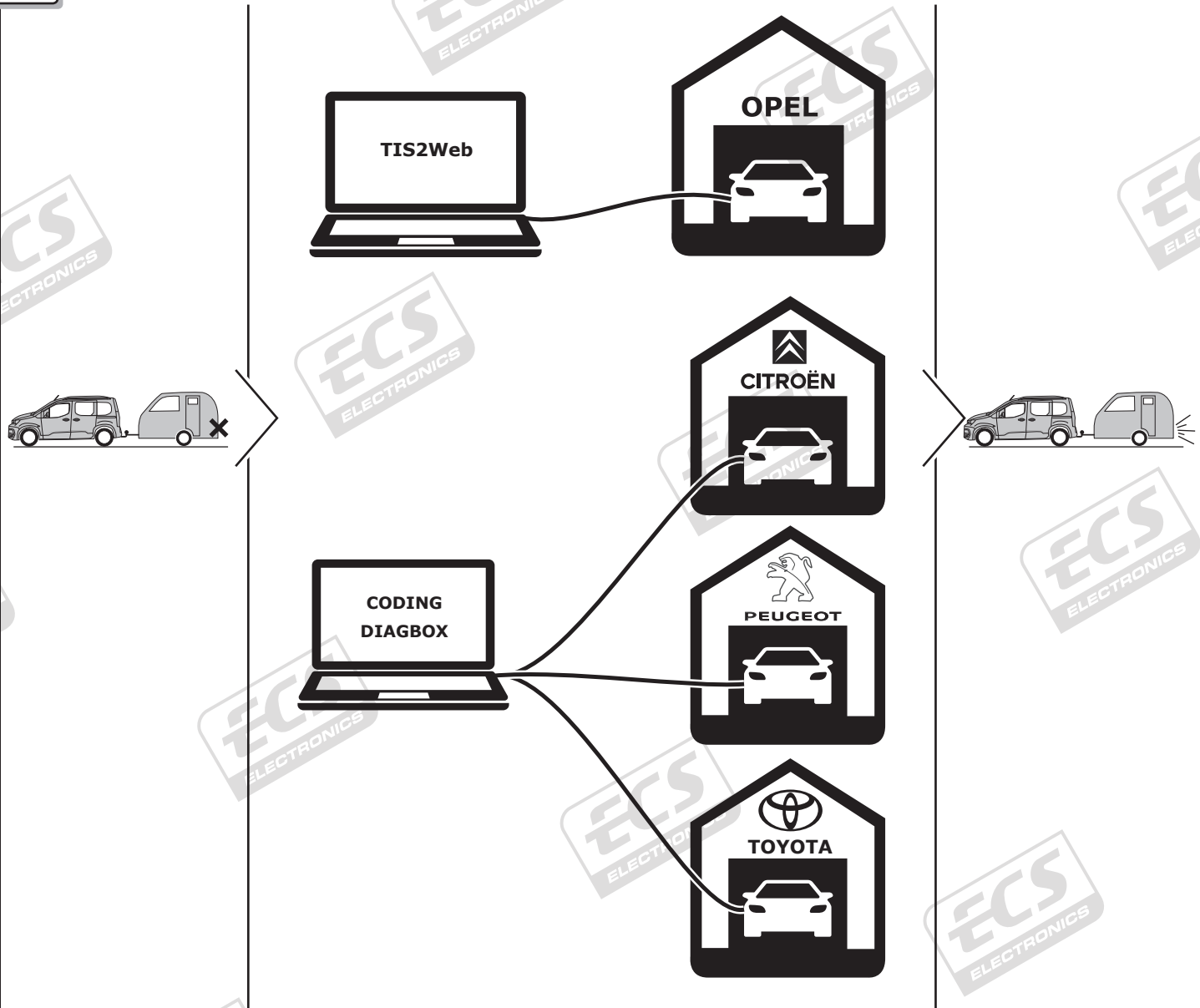

- Ⓓ Fahrzeug codieren für Beleuchtungsfunktionen
- Ⓕ Coder le véhicule pour les fonctions d'éclairage
- Ⓖ Voertuig coderen voor verlichtingsfuncties
- Ⓖ Code vehicle for lighting functions
- Ⓔ Codificar el vehículo para que funcione las luces
- Ⓘ Codificare il veicolo per le funzioni di illuminazione

**INFO**

|    | BK      | BN      | BU    | GY     | GN    | WH     | YE       | OG        | PE      | PI   | RD    |
|----|---------|---------|-------|--------|-------|--------|----------|-----------|---------|------|-------|
| DE | Schwarz | Braun   | Blau  | Grau   | Grün  | Weiß   | Gelb     | Orange    | Violett | Rosa | Rot   |
| FR | Noir    | Marron  | Bleu  | Gris   | Vert  | Blanc  | Jaune    | Orange    | Violet  | PI   | Rouge |
| NL | Zwart   | Bruin   | Blauw | Grijs  | Groen | Wit    | Geel     | Oranje    | Paars   | Roze | Rood  |
| GB | Black   | Brown   | Blue  | Grey   | Green | White  | Yellow   | Orange    | Purple  | Pink | Red   |
| ES | Negro   | Marrón  | Azul  | Gris   | Verde | Blanco | Amarillo | Naranja   | Morado  | Rosa | Rojo  |
| IT | Nero    | Marrone | Blui  | Grigio | Verde | Bianco | Giallo   | Arancione | Viola   | Rosa | Rosso |

**ROUTING**

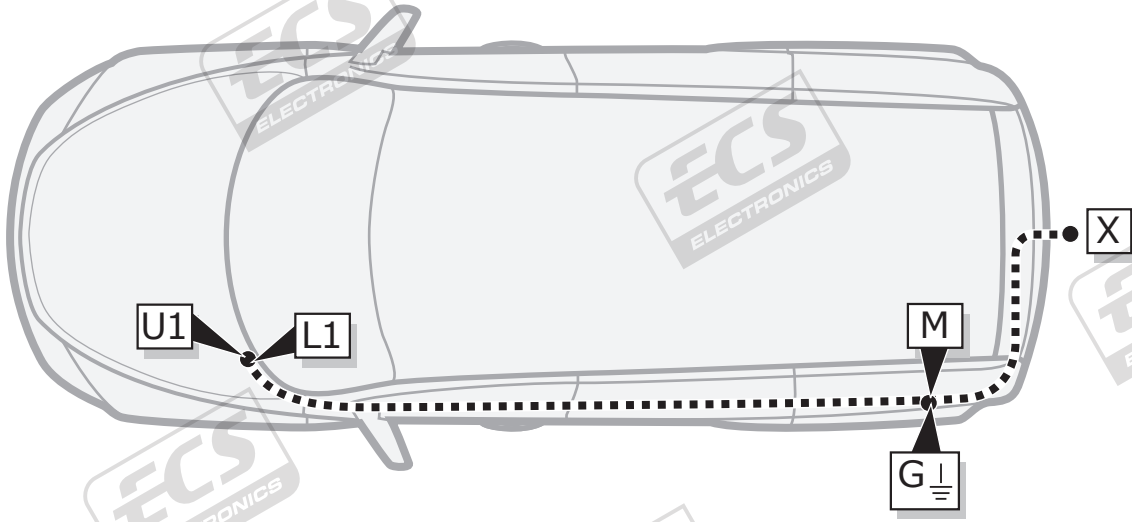

**1**

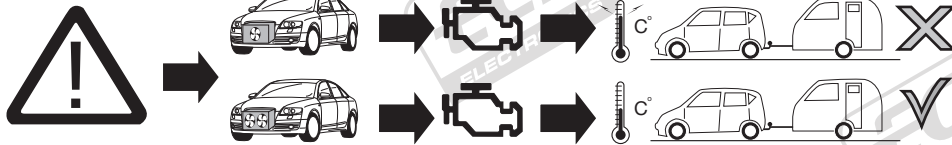

**ACHTUNG!**

DE

Die Kühlerleistung des Fahrzeuges muß bei Nachrüstung einer Anhängerkupplung möglicherweise erhöht werden! Bitte unbedingt Herstellerangaben beachten!!

**ATTENTION!**

FR

Il peut s'avérer nécessaire d'augmenter la puissance du radiateur du véhicule lorsque celui est équipé ultérieurement d'un attelage remorque! Respecter impérativement les instructions du constructeur!!

**ATTENTIE!**

NL

Het koelvermogen van het voertuig moet mogelijk worden verhoogd als achteraf een aanhangerkoppeling wordt aangebracht! Absoluut de fabrieksopgaven in acht nemen a.u.b.!!

**ATTENTION!**

GB

The vehicle's cooling capacity may have to be increased when retrofitting a trailer coupling! You must observe the manufacturer's instructions!!

**¡ATENCIÓN!**

ES

¡Es posible que haya que aumentar la capacidad del radiador en caso de reequipar un acoplamiento de remolque! ¡Rogamos tener en cuenta las instrucciones de fabricante sin falta!

**ATTENZIONE!**

IT

La capacità di raffreddamento del veicolo, quando si applica un gancio di traino, si deve possibilmente aumentare! Si prega di osservare tassativamente le indicazioni del produttore!!

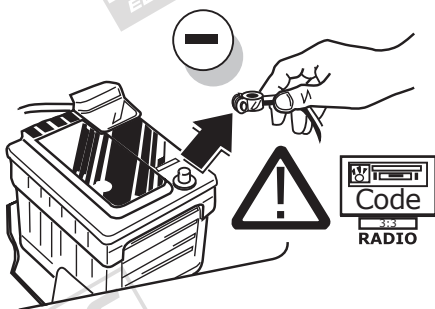

DE

Um Störungen und Schäden am Bordnetz zu vermeiden, muss die Massepolklemme unbedingt vor Beginn aller Arbeiten von der Fahrzeugbatterie getrennt werden! Insbesondere bei Arbeiten und Anschlüssen am CAN-Datenbus kann bei nicht abgeklemmter Batterie sowohl das Anhängermodul als auch das fahrzeugeitige Bordnetzsteuergerät beschädigt werden! Bitte Herstellervorschriften beim Ab- und Anklemmen der Fahrzeugbatterie beachten!

FR

Afin d'éviter tout dys-fonctionnement ou endom-magement du circuit de bord, il est indispensable de débrancher la pince de masse de la batterie du véhicule avant le début de toute opération! En particulier s'il s'agit de travaux et de branchements effectués sur le bus de données CAN, si la batterie n'est pas débranchée, le module remorque aussi bien que le dispositif de commande de circuit de bord du véhicule risquent d'être endommagés! Veuillez respecter les directives du fabricant lors du branchement et du débranchement de la batterie du véhicule!

NL

Om storingen en schade aan de elektrische bedrading te vermijden moet de massapoolklem absoluut vóór aanvang van alle werkzaamheden worden losgekoppeld van de voertuigaccu! Vooral bij werkzaamheden aan en aansluitingen op de CAN-databus kan zowel de aanhangermodule als de voertuigzijdige regeleenheid voor de elektrische installatie beschadigd worden, als de accu niet ontkoppeld is! Fabrieksvoorschriften bij het vast- en loskoppelen van de voertuigaccu in acht nemen a.u.b.!

GB

In order to avoid mal-functions and damage to the vehicle's electrical system the earth terminal must be disconnected from the vehicle's battery before starting work! Both the trailer module and the vehicle's control unit for the electrical system can be damaged during work on the CAN data bus connections if the battery is not disconnected! Please pay attention to the manufacturer's instructions when disconnecting and reconnecting the vehicle's battery!

ES

¡Para evitar fallos y defectos en el sistema eléctrico de a bordo es imprescindible separar al terminal de puesta a tierra de la batería del vehículo antes de realizar cualquier trabajo! ¡Particularmente al realizar trabajos y conexiones al bus de datos CAN puede estropearse tanto el módulo para remolques como el regulador del sistema eléctrico de a bordo del vehículo si no se ha desconectado la batería! ¡Rogamos observar las instrucciones del fabricante al conectar y desconectar la batería del vehículo!

IT

Per evitare disturbi e danni alla rete di distribuzione elettrica, l'espansione polare a massa deve essere assolutamente scollegata dalla batteria del veicolo prima dell'inizio dei lavori! In particolare durante i lavori e gli allacciamenti al bus di dati CAN, se la batteria non è scollegata si possono danneggiare sia la centralina rimorchio, sia la centralina della rete di distribuzione elettrica del veicolo! Attenersi alle indicazioni del costruttore per scollegare e ricollegare la batteria del veicolo!



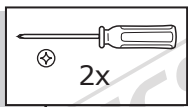
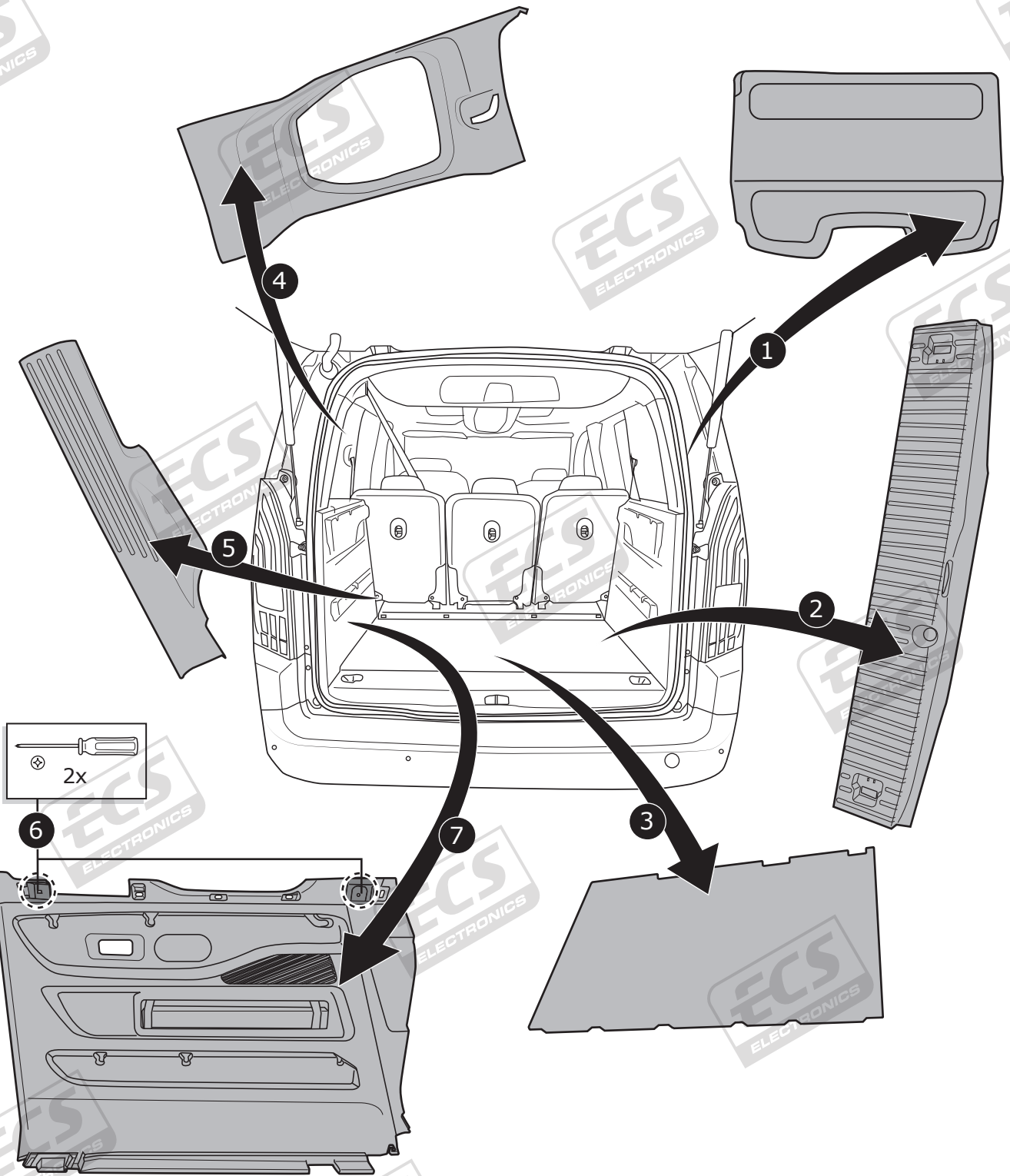

3

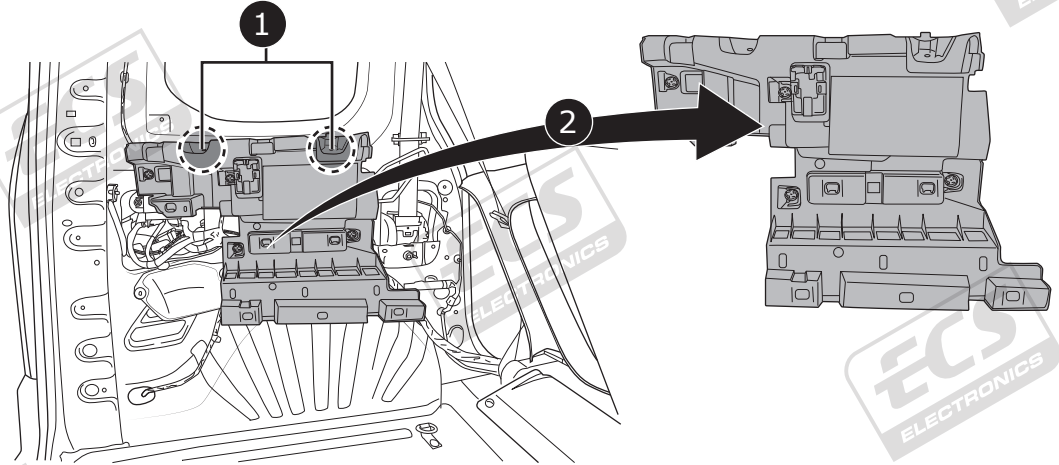
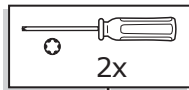
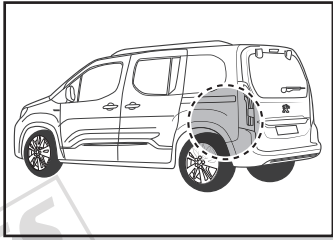

4

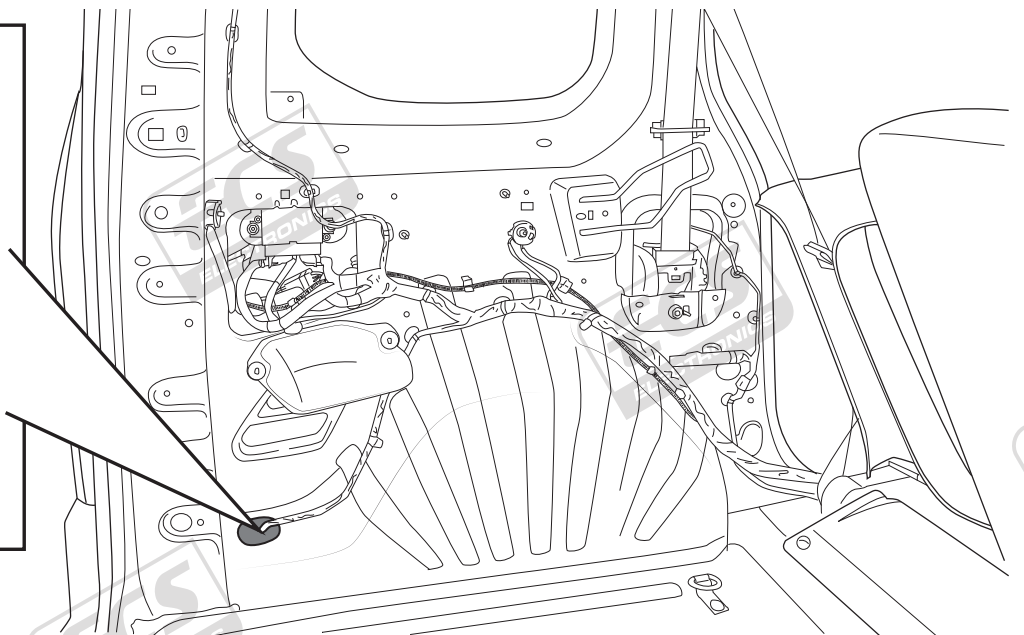
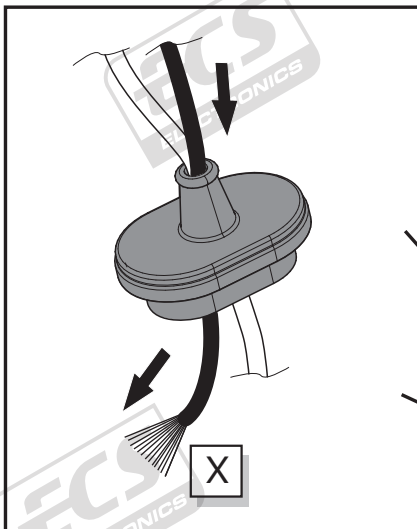
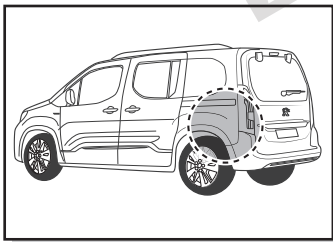

**A**

**Option 1**

**Option 2**

**INFO**

- (DE) Anschluss Steckdose
- (FR) Connection de la prise
- (NL) Contactdoos aansluiting
- (GB) Socket connection
- (ES) Conexión de la caja de enchufe
- (IT) Allaccio zoccolo

**Option 3**

Page 20

**B**

**Option 1**

**C**

**Option 2**

- 1
- 2
- 3
- 4

**D**

**Option 3**

- 1
- 2
- 3
- 4

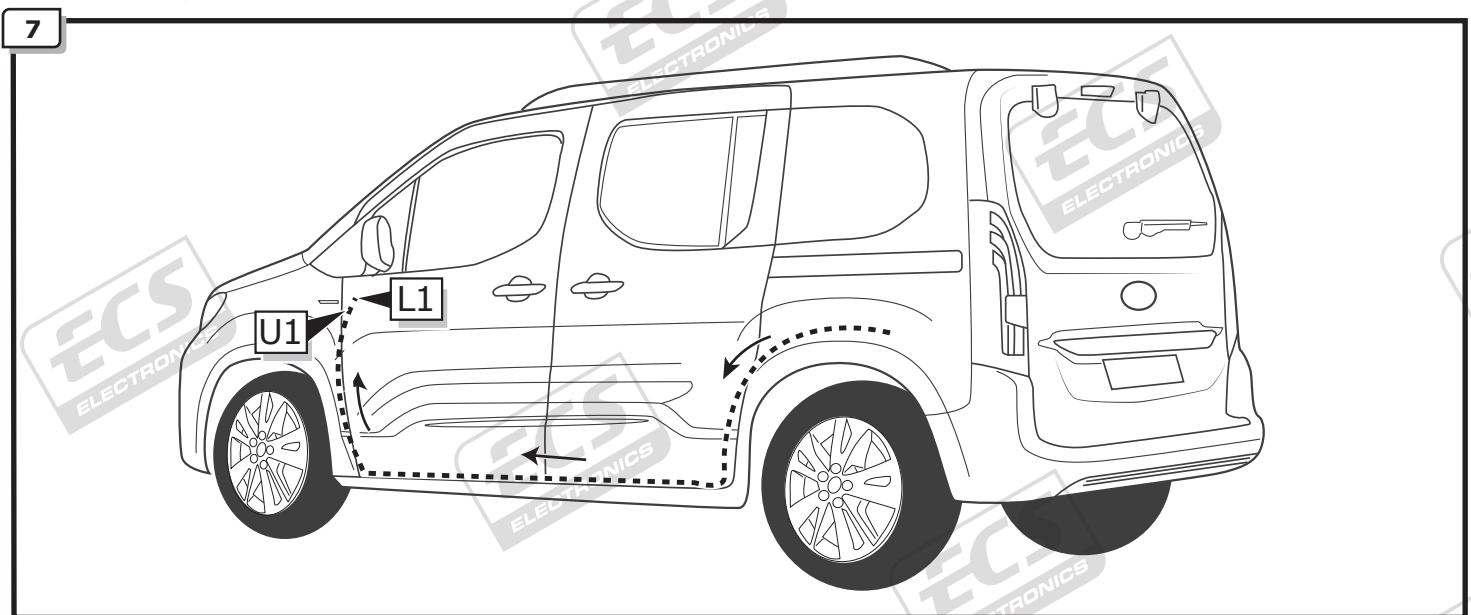
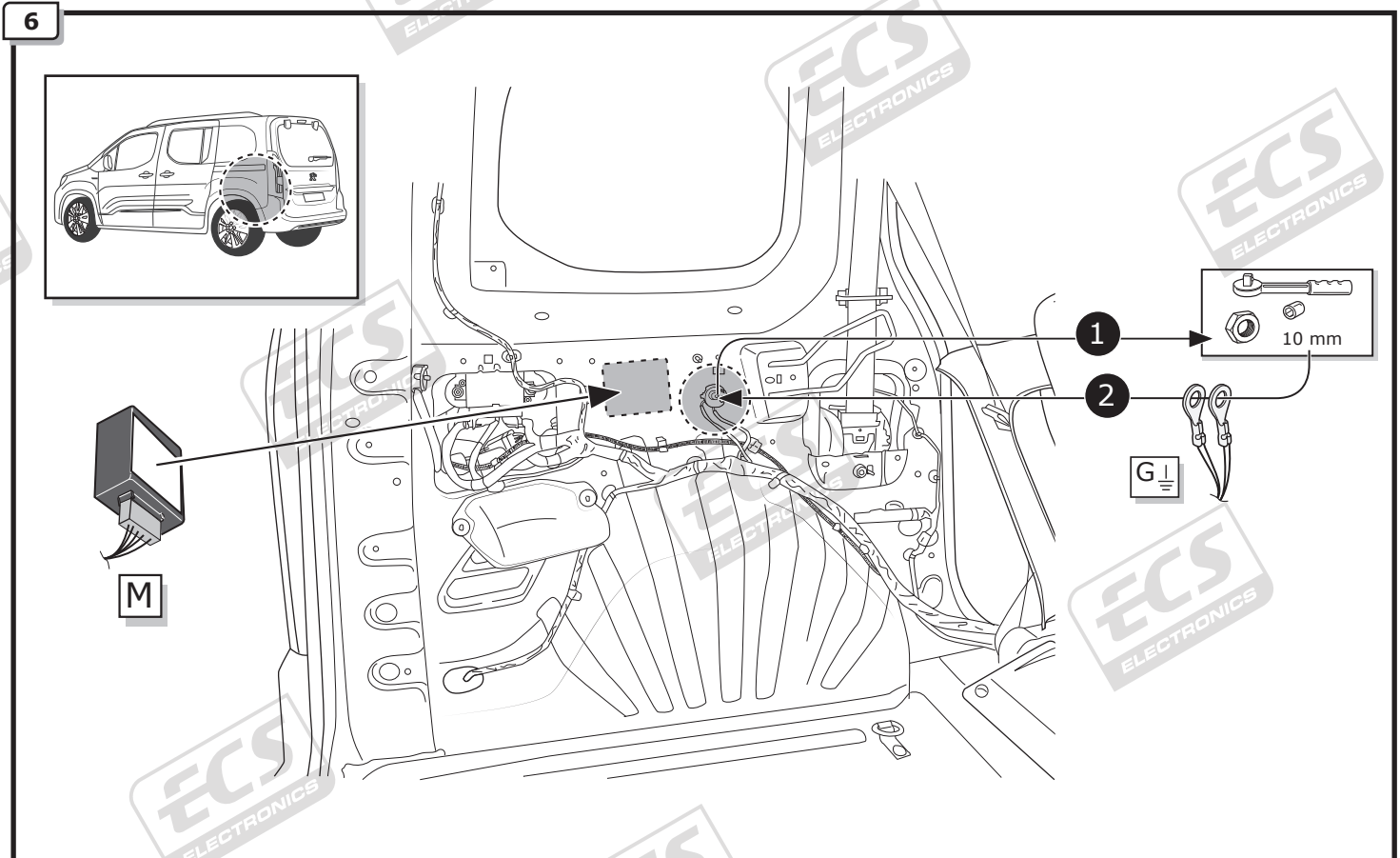
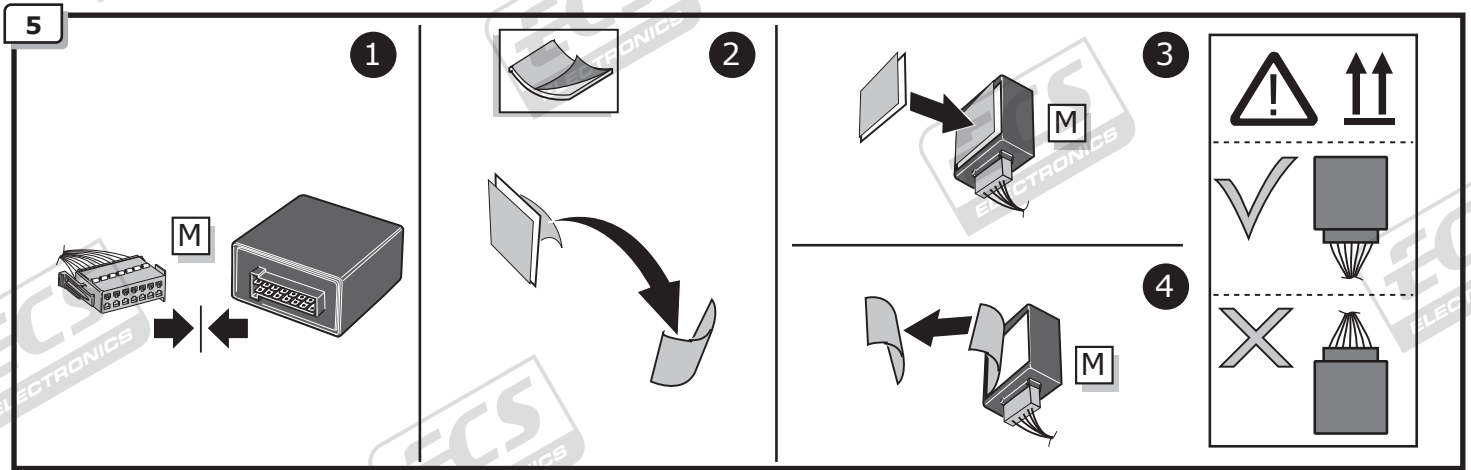



8

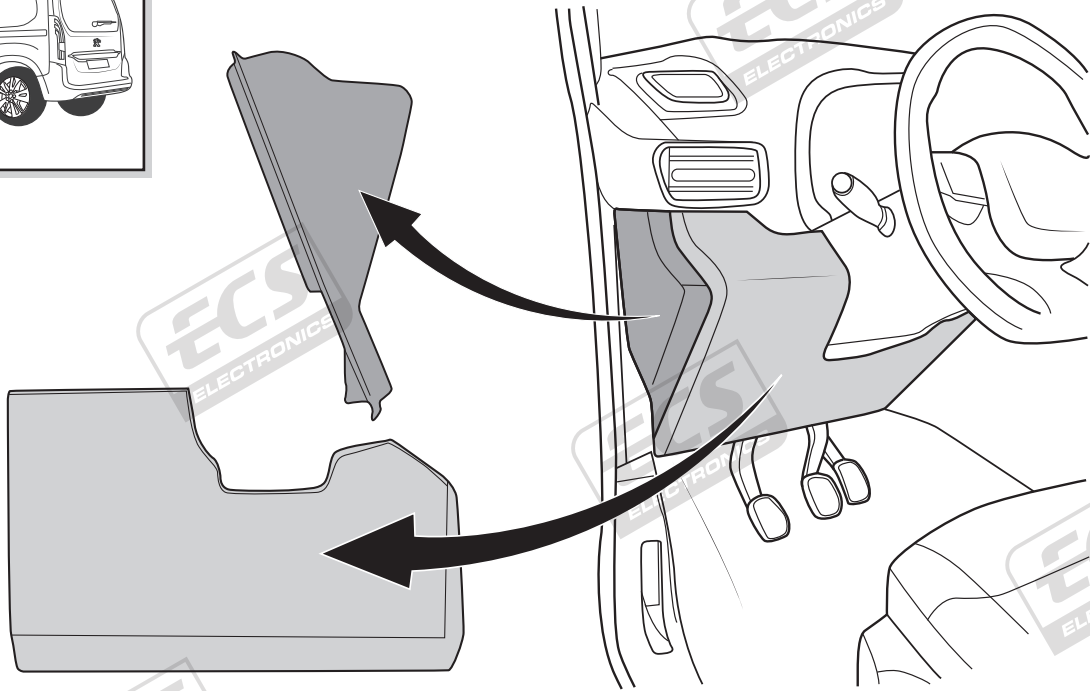
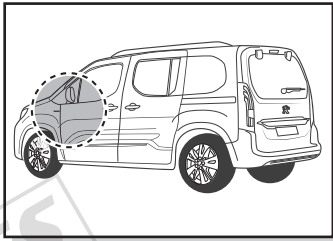

9

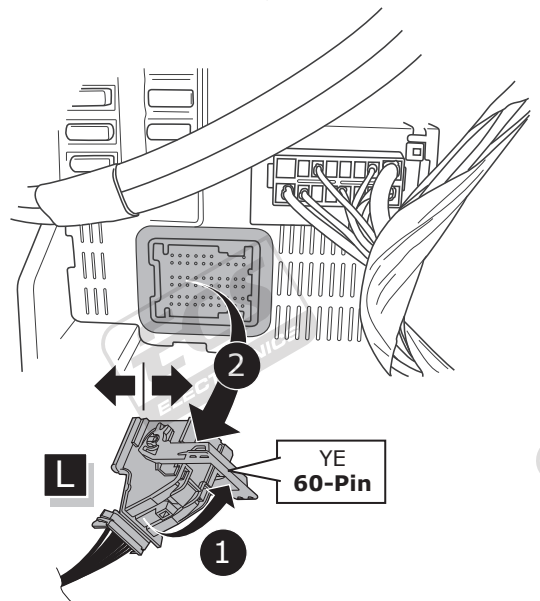
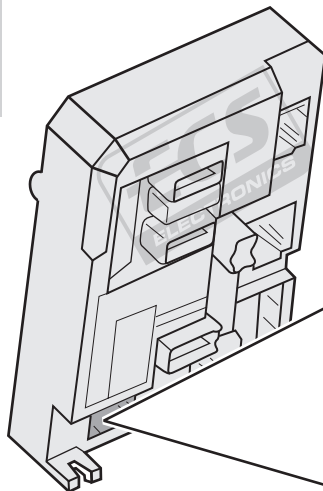
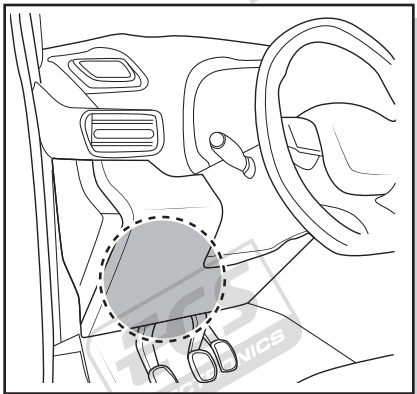

10

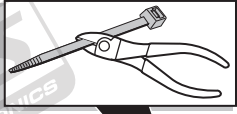

1

L

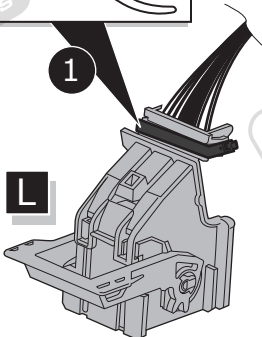

L

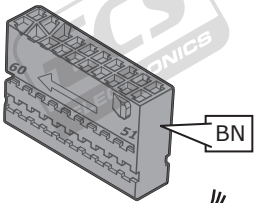
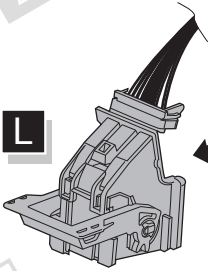

2



11 - 29

~~11.1~~

3

L

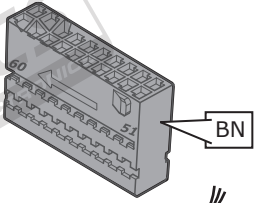
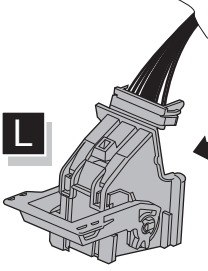

~~11.1~~

13 - 14

19 - 29

11

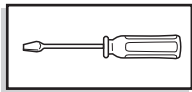

Open Lock!

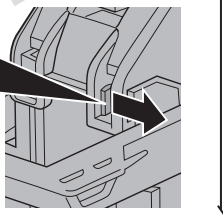

2

L

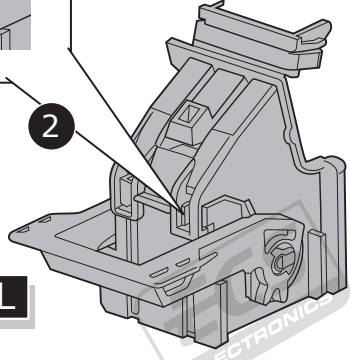

3

L1

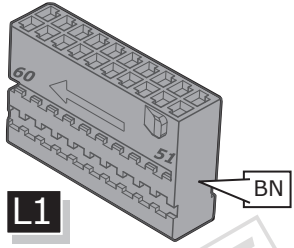

1

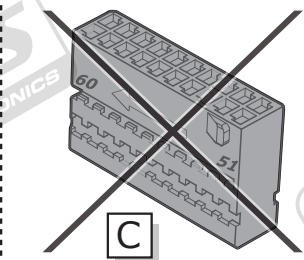

REUSEABLE

11.1

L

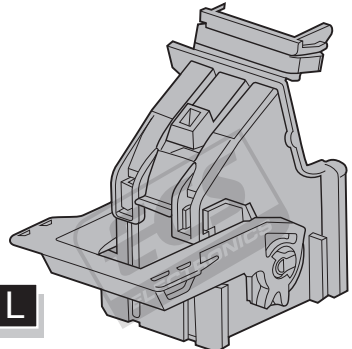

BN

C

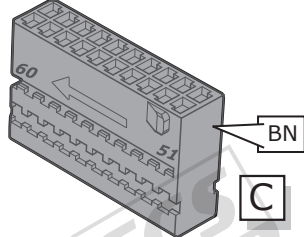

12

**Option 1**

If positions 47/49/52 are empty  
 Si les positions 47/49/52 sont vides  
 Wenn die Positionen 47/49/52 leer sind  
 Als de posities 47/49/52 leeg zijn

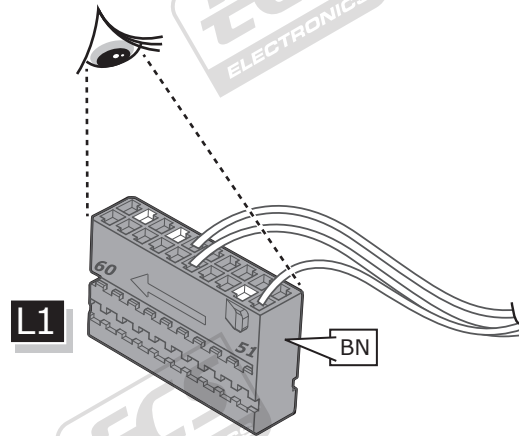

13

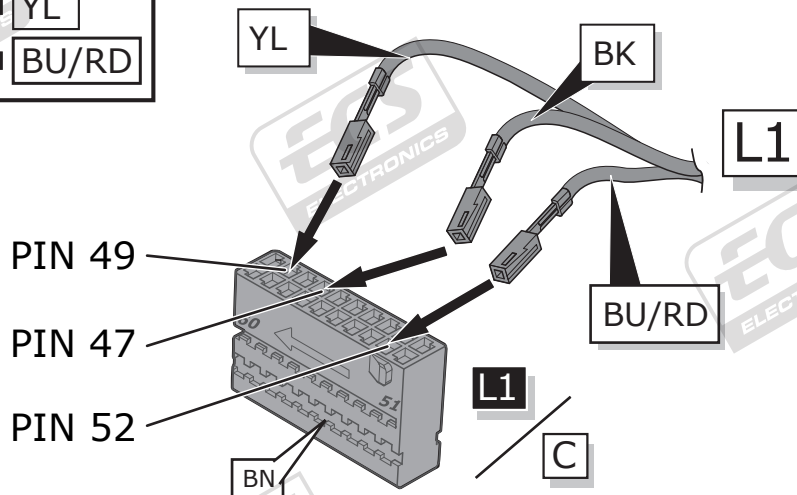
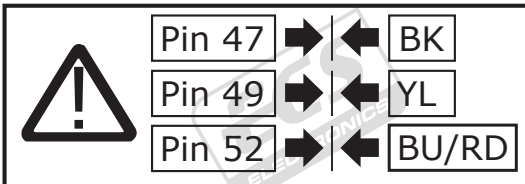

14

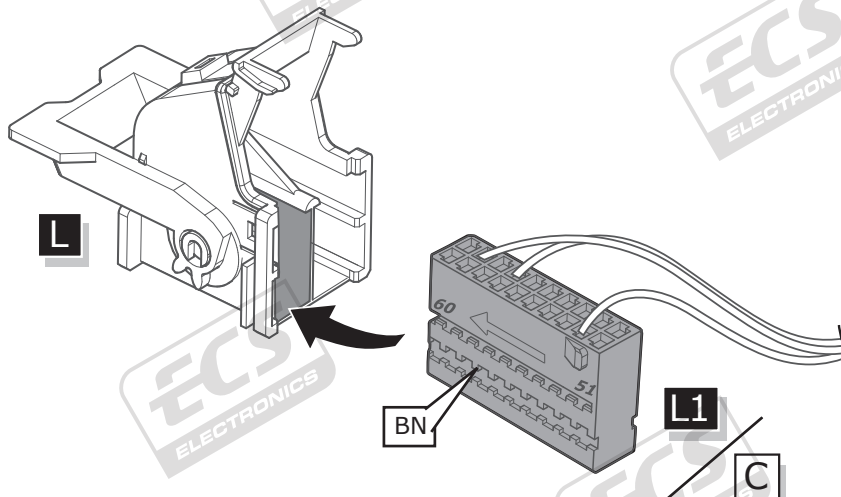

15

**Option 2**

If positions 47/49/52 are occupied  
 Si les positions 47/49/52 sont occupées  
 Wenn die Positionen 47/49/52 besetzt sind  
 Als de posities 47/49/52 bezet zijn

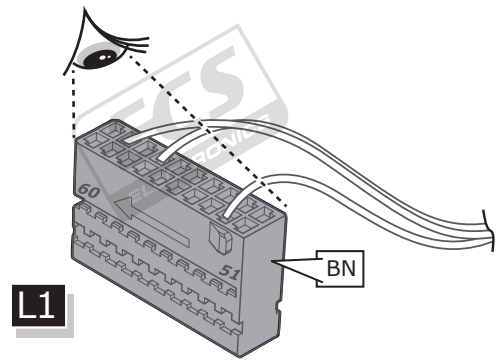

16

Remove wires from positions 47/49/52 and isolate them  
 Retirez les fils des positions 47/49/52 et isolez les  
 Leitungen aus den Positionen 47/49/52 entnehmen und isolieren  
 Verwijder de draden van posities 47/49/52 en tape deze af

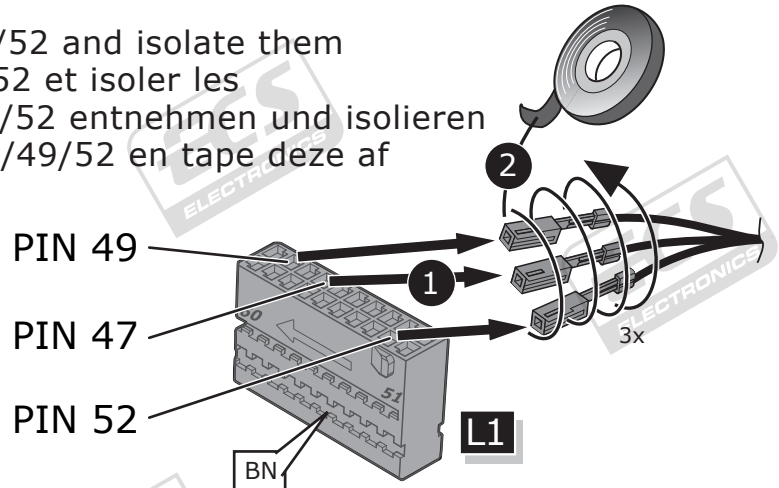

17

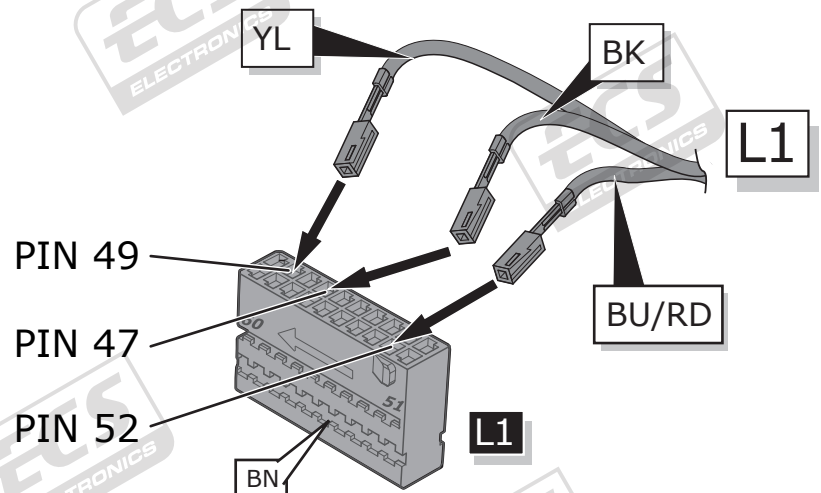
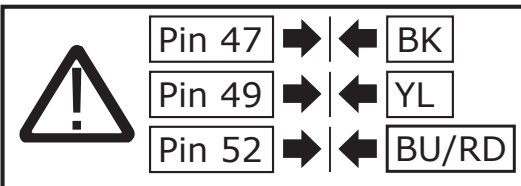

18

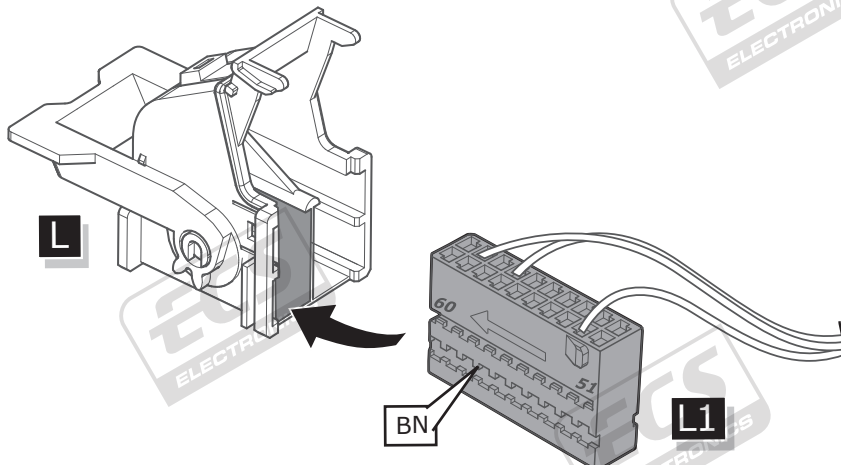



19

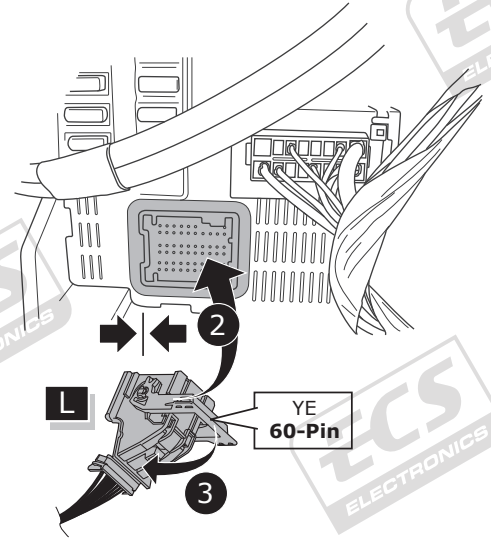
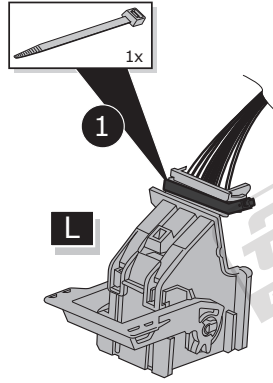
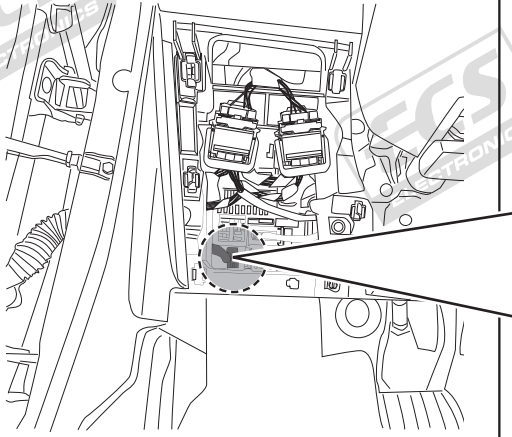

20

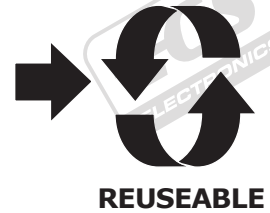
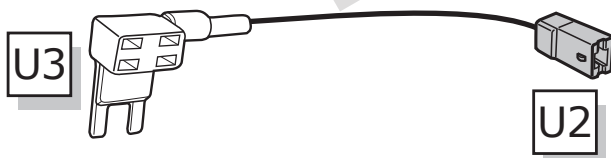
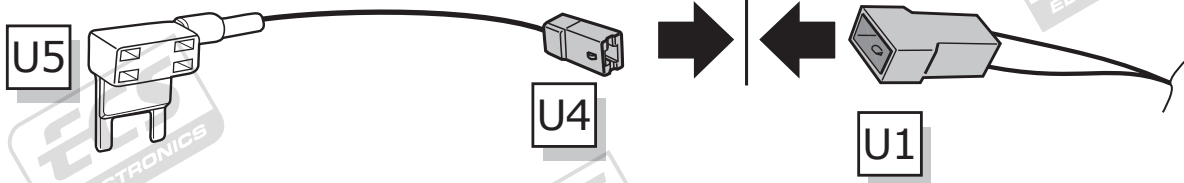

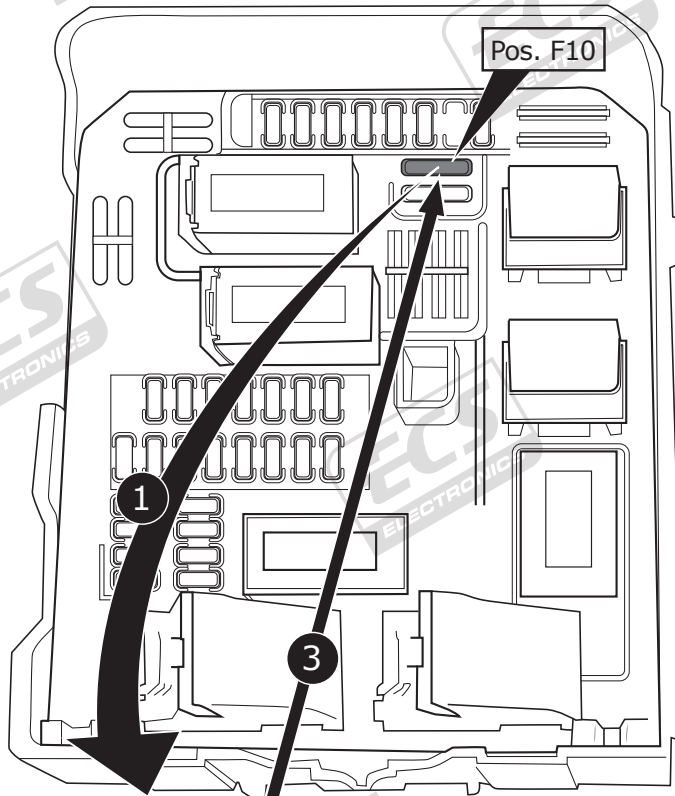
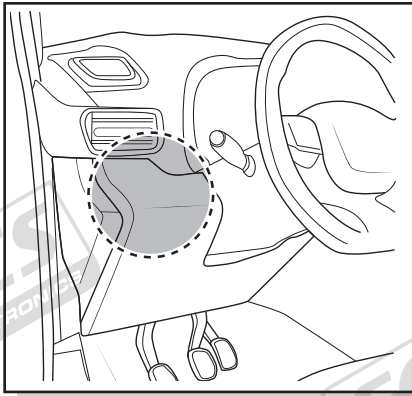

**!**

**Wichtig!**  
Die Sicherungsbrücke darf nicht in entgegengesetzter Richtung eingebaut werden!

**Important!**  
Please do not mount the fuse tap and its wiring output in the other direction!

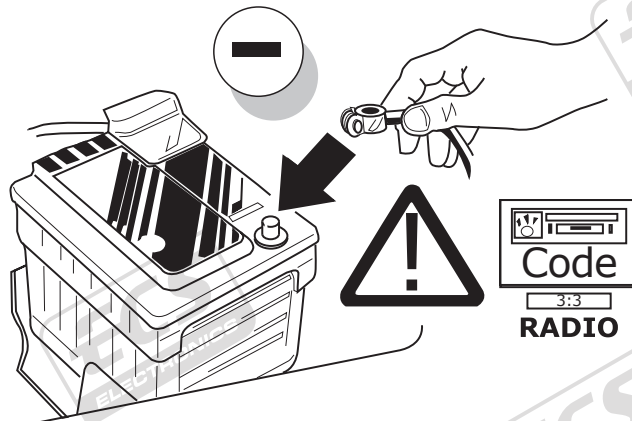
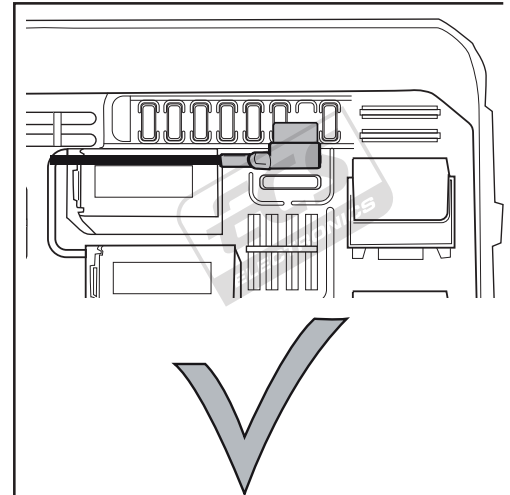
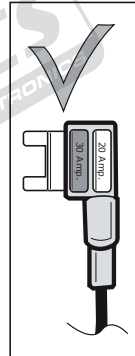
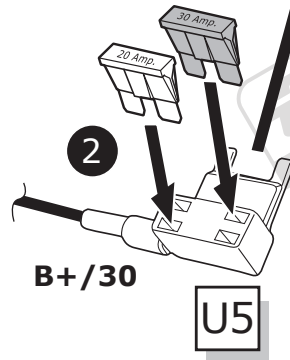

OPEL

Combo Life / Life XL

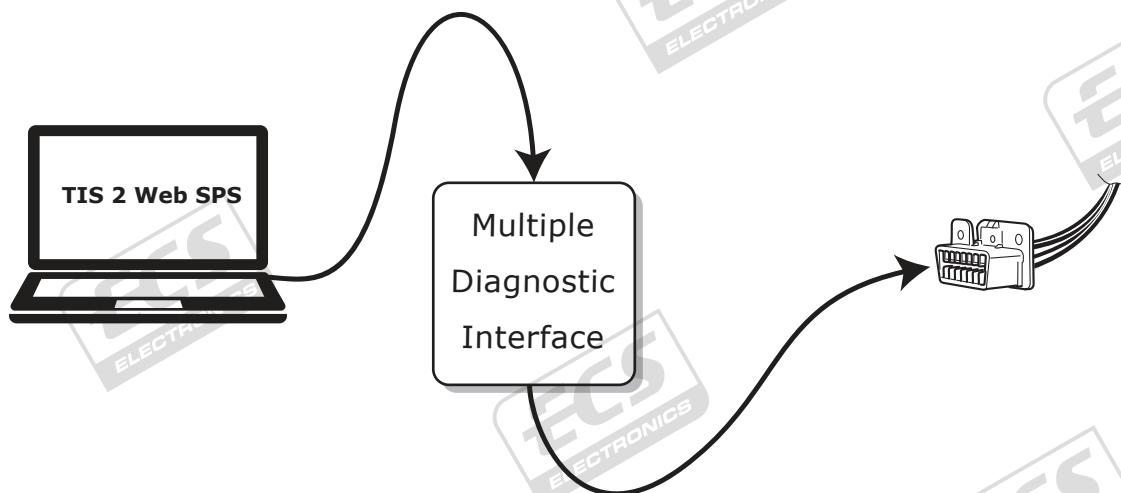
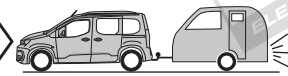
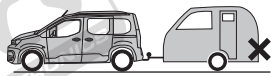

DE

#### Die Aktivierung der Anhängerfunktionen

muss mit Hilfe des OPEL TIS 2 WEB SPS wie folgt durchgeführt werden:

- Fahrzeug auswählen
- Z6 Fahrzeugoptionen ändern
  - > Anhängerzugvorrichtung hinzufügen
  - > Normal
- Installation starten

GB

#### The activation of the trailer functions

has to be carried out using the OPEL TIS 2 WEB SPS as follows:

- choose vehicle
- Z6 change vehicle options
  - > add Trailer Hitch
  - > normal
- start installation

FR

#### L'activation des fonctions de la remorque

doit être effectuée comme suit à l'aide du testeur OPEL TIS 2 WEB SPS:

- choisir des véhicules
- Z6 modifier les options du véhicule
  - > ajouter remorque
  - > normalement
- commencer l'installation

IT

#### L'attivazione di rimorchio funzioni

si deve eseguire con l'aiuto del tester OPEL TIS 2 WEB SPS come segue:

- Scegliere veicolo
- Z6 cambia le opzioni del veicolo
  - > aggiungere rimorchio
  - > normalmente
- avvia l'installazione

ES

#### La activación del funciones de remorque

deberá llevarse a cabo con ayuda del comprobador de OPEL TIS 2 WEB SPS de la siguiente manera:

- elegir vehículo
- Z6 cambiar las opciones del vehículo
  - > añadir remorque
  - > normalmente
- comenzar la instalación

NL

#### De activering van de trailer-functies

moet met behulp van de OPEL TIS 2 WEB SPS als volgt worden uitgevoerd:

- Kies het voertuig
- Z6 verander voertuigopties
  - > aanhanger toevoegen
  - > normaal
- start de installatie

**CITROËN**

Berlingo M / XL

**PEUGEOT**

Rifter L1 / L2

Partner L1 / L2

**TOYOTA**

Proace City L1 / L2

Proace City Verso L1 / L2



DE

**Die Aktivierung der Anhängerfunktionen muss mit Hilfe des CITROËN DIAGBOX wie folgt durchgeführt werden:**

- Fahrzeug auswählen
- Auslieferung
- Ausstattungen
- Schalteinheit Anhänger (BSR)
- Installation einer Ausstattung

GB

**The activation of the trailer functions has to be carried out using the CITROËN DIAGBOX as follows:**

- choose vehicle
- delivery
- equipment
- trailer control unit (BSR)
- installation of equipment

FR

**L'activation des fonctions de la remorque doit être effectuée comme suit à l'aide du testeur DIAGBOX CITROËN:**

- choisir des véhicules
- livraison
- équipements
- partie commutation - remorque (BSR)
- installation d'un équipement

IT

**L'attivazione di rimorchio funzioni si deve eseguire con l'aiuto del tester CITROËN DIAGBOX come segue:**

- Scegliere veicolo
- I tempi di consegna
- Attrezzature
- Centralina rimorchio (BSR)
- L'installazione di apparecchiature

ES

**La activación del funciones de remolque**

**• del control de los intermitentes del remolque  
• de la desactivación del sistema de ayuda al aparcamiento**

- elegir vehículo
- entrega
- equipo
- unidad de conmutación - remolque (BSR)
- instalación de equipos i

NL

**De activering van de trailer-functies**

**moet met behulp van de CITROËN DIAGBOX als volgt worden uitgevoerd:**

- Kies het voertuig
- Levering
- Apparatuur
- Schakelunit aanhanger (BSR)
- Installatie van apparatuur



**Functional test**

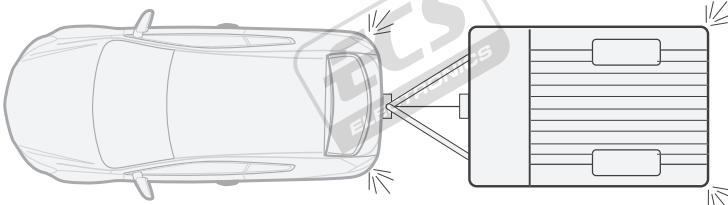
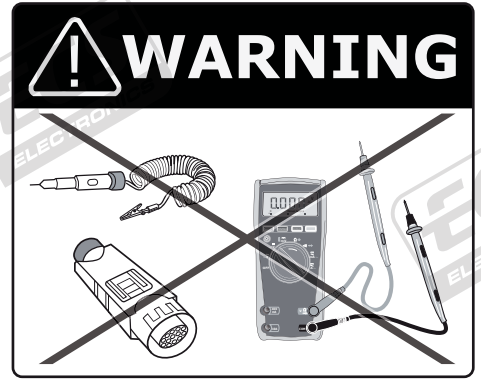
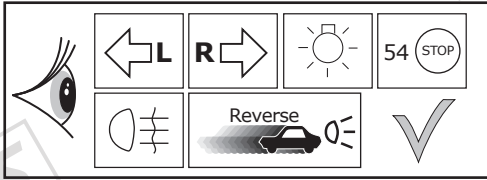

**LIGHT MATE**

**ECS** part no.  
**LIGHTMATEII**  
**LIGHTMATEIII**

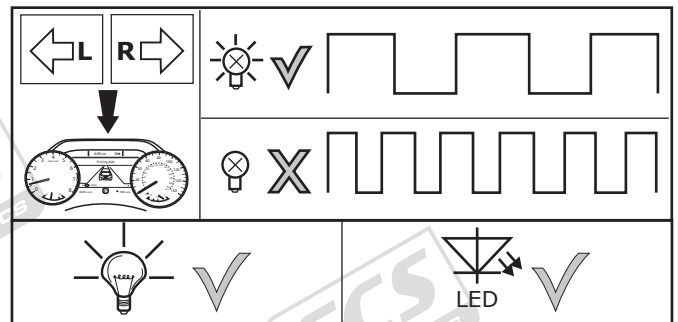
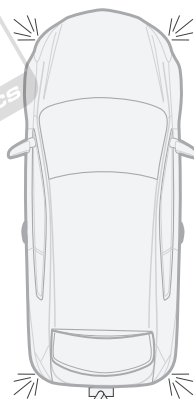
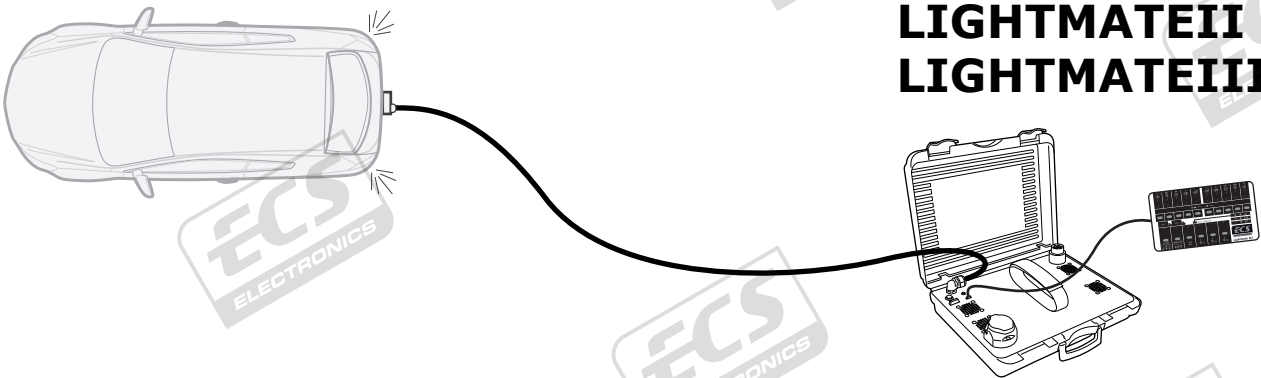

27

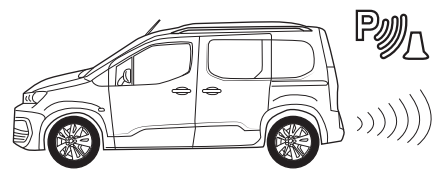
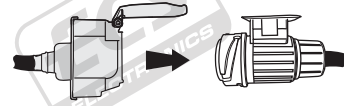
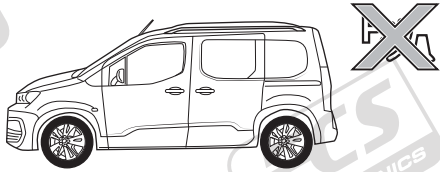
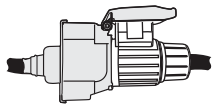

28

**Optional**  
**Adapter socket**

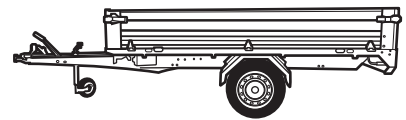
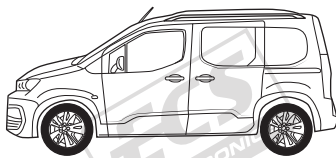

29

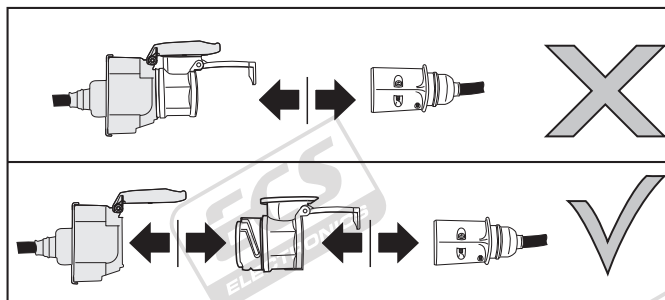
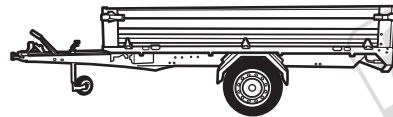
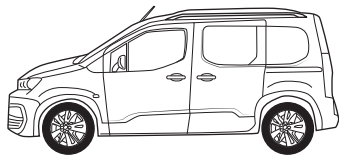

INFO

**Products & Service:** <https://www.ecs-electronics.nl/test-equipment>

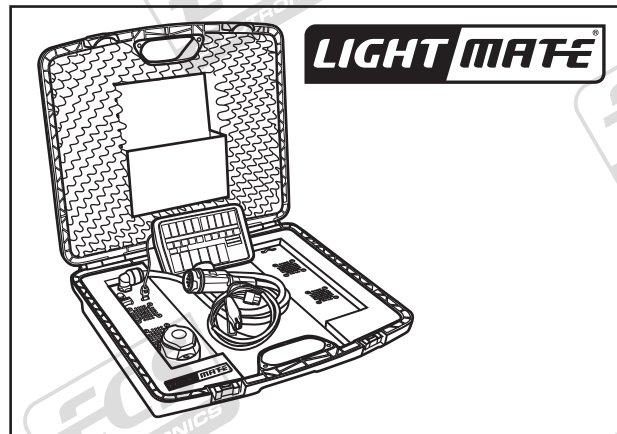
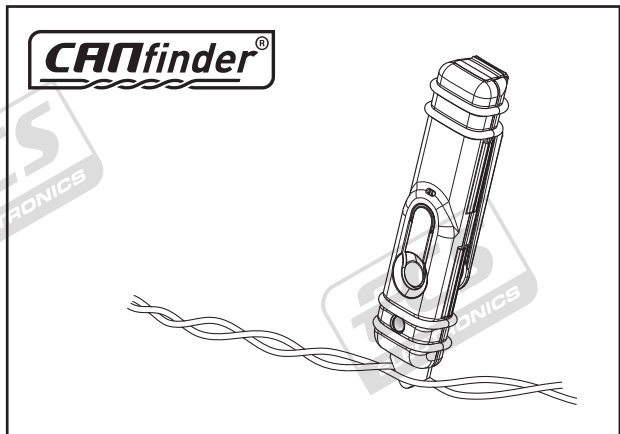

INFO

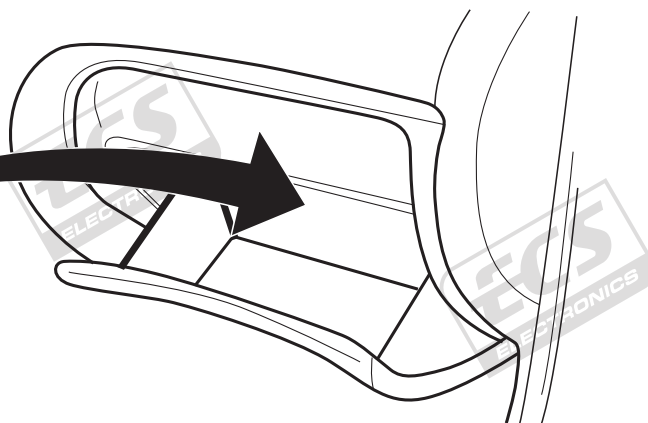
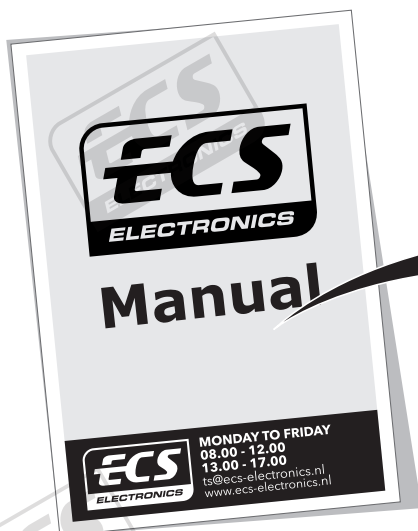

**FITTERS  
TECHNICAL  
SUPPORT**



**MONDAY TO FRIDAY**  
**08.00 - 12.00**  
**13.00 - 17.00**

ts@ecs-electronics.nl  
www.ecs-electronics.nl  
tel: +31 (0)76 573 0020

**INFO**

- (DE) Anschluss Steckdose      (ES) Conexión de la caja de enchufe      (CZ) Objímkový konektor      (GR) Υποδοχή σύνδεσης
- (FR) Connection de la prise      (IT) Allaccio zoccolo      (DK) Stikdåse forbindelse      (NO) Tilkobling koblingsboks
- (NL) Contactdoos aansluiting      (SE) Anslutning kontaktdosa      (FI) Pistorasia liitäntä      (PL) Połączenie przez gniazdo
- (GB) Socket connection

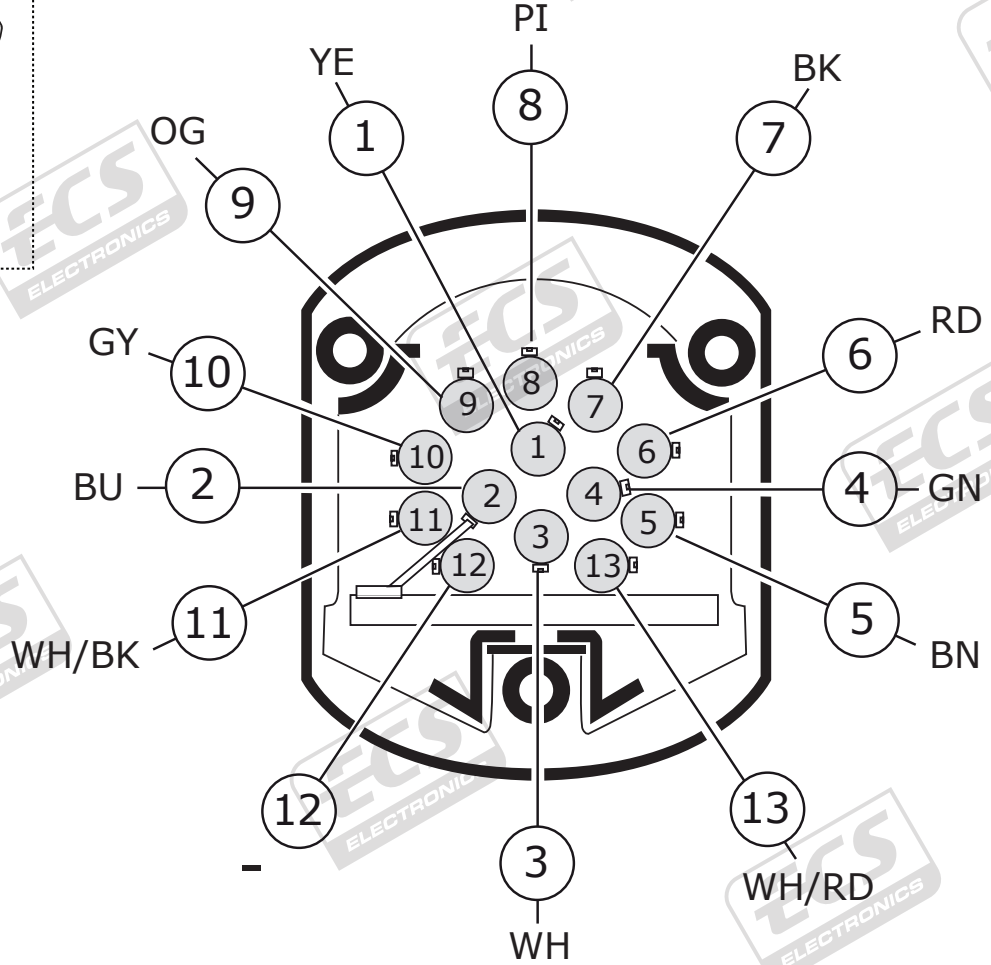
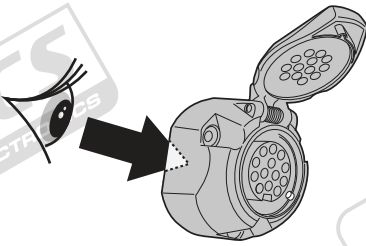

- (DE) Anschluss Steckdose      (ES) Conexión de la caja de enchufe      (CZ) Objímkový konektor      (GR) Υποδοχή σύνδεσης
- (FR) Connection de la prise      (IT) Allaccio zoccolo      (DK) Stikdåse forbindelse      (NO) Tilkobling koblingsboks
- (NL) Contactdoos aansluiting      (SE) Anslutning kontaktdosa      (FI) Pistorasia liitäntä      (PL) Połączenie przez gniazdo
- (GB) Socket connection

|               |     |     |    |     |     |       |     |     |            |            |       |   |       |
|---------------|-----|-----|----|-----|-----|-------|-----|-----|------------|------------|-------|---|-------|
| DIN/ISO 11446 |     |     |    |     |     |       |     |     |            |            |       |   |       |
| Pmax          | 21W | 21W |    | 21W | 52W | 3x21W | 52W | 21W | 180W/15Amp | 180W/15Amp |       |   |       |
|               | YE  | BU  | WH | GN  | BN  | RD    | BK  | PI  | OG         | GY         | WH/BK | - | WH/RD |

**COLORTABLE**

|      | BK      | BN      | BU        | GY     | GN      | WH        | YE        | OG           | PE        | PI              | RD       |
|------|---------|---------|-----------|--------|---------|-----------|-----------|--------------|-----------|-----------------|----------|
| (DE) | Schwarz | Braun   | Blau      | Grau   | Grün    | Weiß      | Gelb      | Orange       | Violett   | Rosa            | Rot      |
| (FR) | Noir    | Marron  | Blue      | Gris   | Vert    | Blanc     | Jaune     | Orange       | Violet    | Rose            | Rouge    |
| (NL) | Zwart   | Bruin   | Blauw     | Grijs  | Groen   | Wit       | Geel      | Oranje       | Paars     | Roze            | Rood     |
| (GB) | Black   | Brown   | Blue      | Grey   | Green   | White     | Yellow    | Orange       | Purple    | Pink            | Red      |
| (ES) | Negro   | Marrón  | Azul      | Gris   | Verde   | Blanco    | Amarillo  | Naranja      | Morado    | Rosa            | Rojo     |
| (IT) | Nero    | Marrone | Blu       | Grigio | Verde   | Bianco    | Giallo    | Arancione    | Viola     | Rosa            | Rosso    |
| (SE) | Svart   | Brun    | Blå       | Grå    | Grön    | Vit       | Gul       | Orange       | Lila      | Rosa            | Röd      |
| (CZ) | Černá   | Hnědá   | Modrá     | Šedá   | Zelená  | Bílá      | Žlutá     | Oranžová     | Fialová   | Růžová          | Červená  |
| (DK) | Sort    | Brun    | Blå       | Grå    | Grøn    | Hvid      | Gul       | Orange       | Lilla     | Pink            | Rød      |
| (FI) | Musta   | Ruskea  | Sininen   | Harmaa | Vihreä  | Valkoinen | Keltainen | Oranssi      | Purppura  | Vaaleanpunainen | Punainen |
| (GR) | Μαύρο   | Καφέ    | Μπλε      | Γκρι   | Πράσινο | Λευκό     | Κίτρινο   | Πορτοκαλί    | Μοβ       | Ροζ             | Κόκκινο  |
| (NO) | Svart   | Brun    | Blå       | Grå    | Grønn   | Hvit      | Gul       | Oransje      | Lilla     | Rosa            | Rød      |
| (PL) | Czarny  | Brazowy | Niebieski | Szary  | Zielony | Biały     | Żółty     | Pomarańczowy | Purpurowy | Różowy          | Czerwony |