



06/2012 -

DACIA LODGY

Cat. No. **G/007**

E20

E20 55R-01 3761

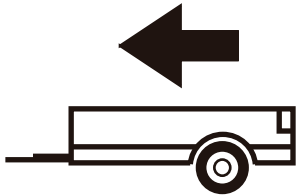

1400Kg

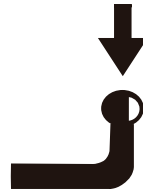

75Kg

D = 8,08kN

D (kN) =



MAX kg

x

MAX kg

x 0,00981



MAX kg

+

MAX kg

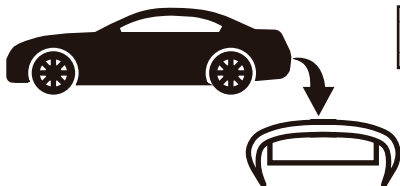

IMIOLA HAK-POL

96-111 KOWIESY, CHOJNATA 23A, POLAND

Tel. + 48 46 831 73 31, fax +48 831 74 29

e-mail: office@imiola.pl, www.imiola.pl



PRZEKRÓJ A-A

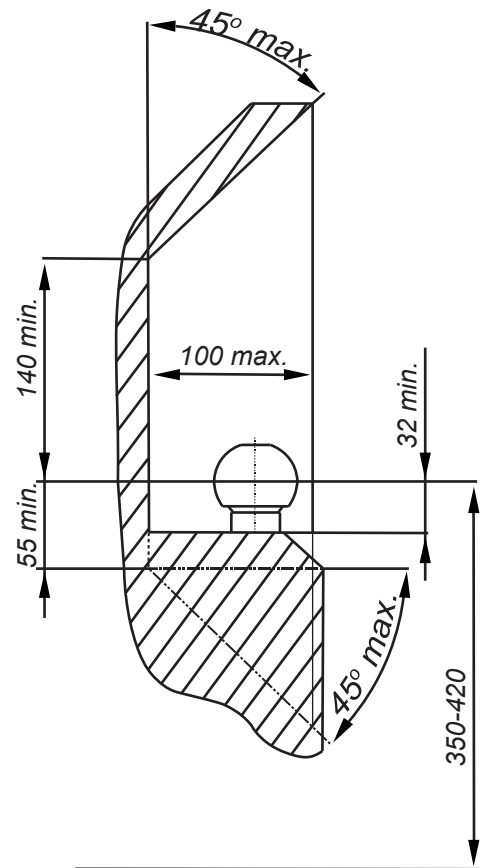

PL Należy zagwarantować przestrzeń swobodną według załącznika VII, rysunek 25a/b Regulaminu EKG ONZ 55.01 przy dopuszczalnym ciężarze całkowitym pojazdu.

F L'espace libre doit être garanti conformément à l'annexe VII, illustration de la réglementation 55.01 CE pour un poids total en charge autorisé du véhicule.







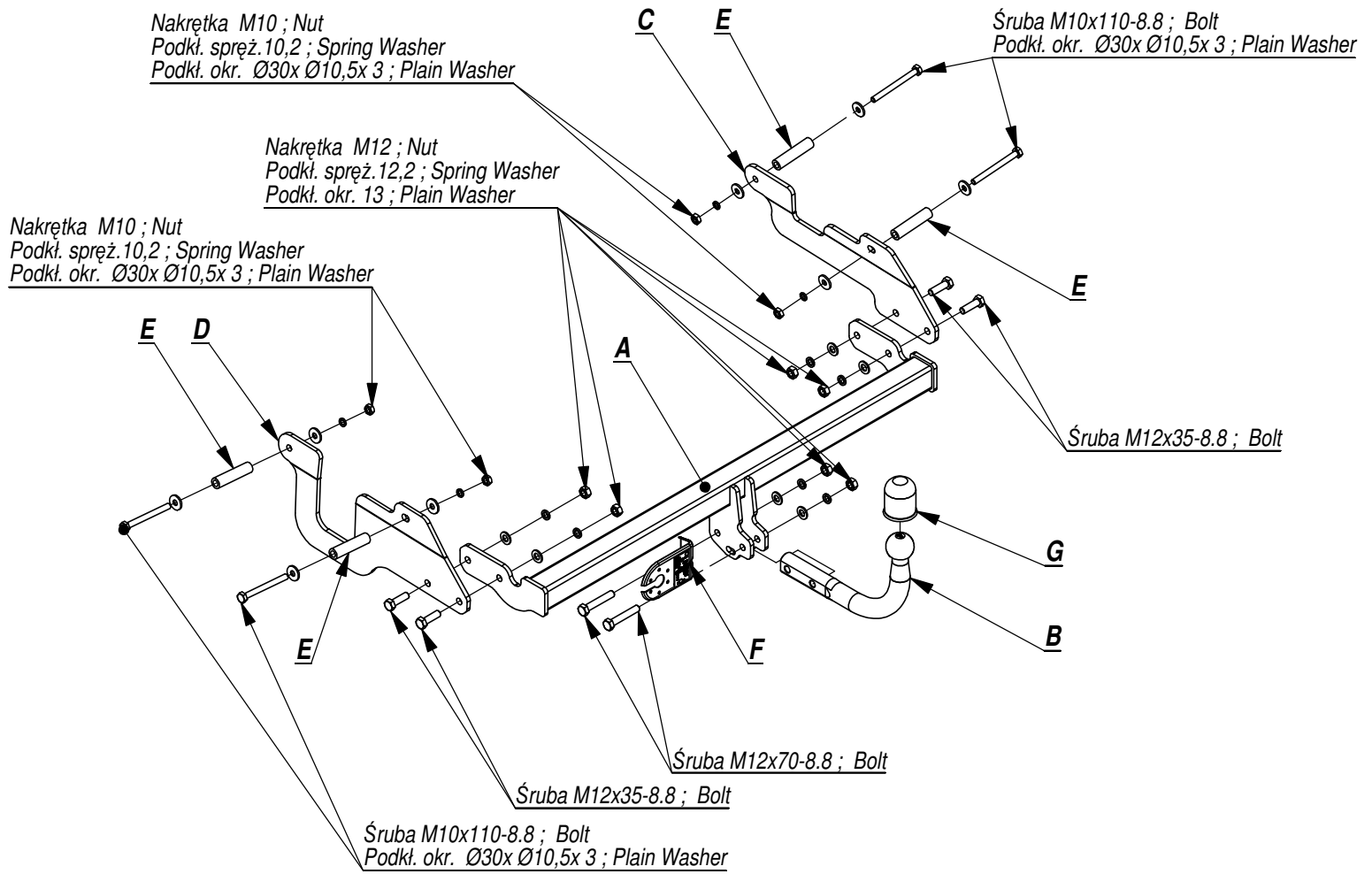

GB The clearance specified in appendix VII, diagram 25a/b of Regulation No. 55.01 UN EU must be guaranteed at laden weight of the vehicle.

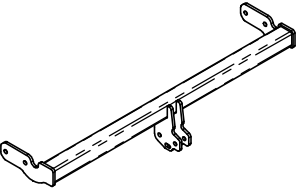
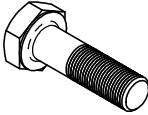
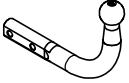
D Der Freiraum nach Anhang VII, Abbildung 25a/b der Vorschriften 55.01 EG ist zu gew 25a/bahrleisten bei zulässigem Gesamtgewicht des Fahrzeuges.

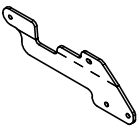
Moment skręcający dla śrub i nakrętek (8.8) Torque settings for nuts and bolts (8.8)	
M8	25Nm
M10	55Nm
M12	85Nm
M14	135Nm
M16	195Nm

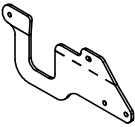
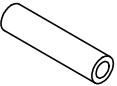



	A	x1		M12x70	2
				M12x35	4
				M10x110	4
	B	x1		M12	6
				M10	4
	C	x1		Ø30xØ10,5x3	8
	D	x1		13	6
 2x 1/2x70 2x 1/2x75	E	x4		12,2	6
				10,2	4
	F	x1			
	G	x1			

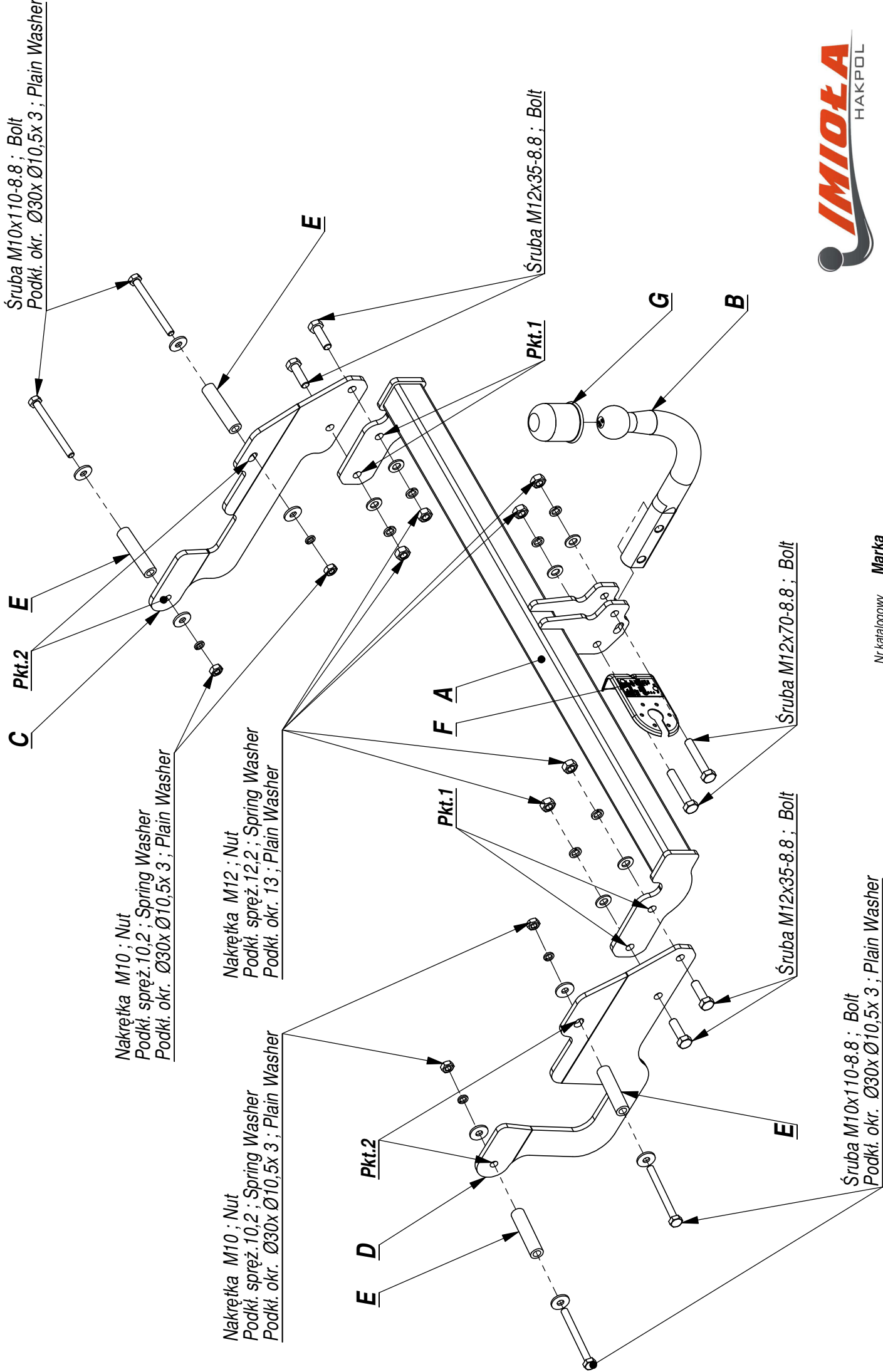

Śruba M10x110-8.8 ; Bolt
Podkl. okr. Ø30x Ø10,5x 3 ; Plain Washer

C Pkt.2 E

Nakrętka M10 ; Nut
Podkl. spręż.10,2 ; Spring Washer
Podkl. okr. Ø30x Ø10,5x 3 ; Plain Washer

Nakrętka M10 ; Nut
Podkl. spręż.10,2 ; Spring Washer
Podkl. okr. Ø30x Ø10,5x 3 ; Plain Washer

Nakrętka M12 ; Nut
Podkl. spręż.12,2 ; Spring Washer
Podkl. okr. 13 ; Plain Washer

E D Pkt.2

F A

Pkt.1

Śruba M12x35-8.8 ; Bolt

Pkt.1

Śruba M12x70-8.8 ; Bolt

Śruba M12x35-8.8 ; Bolt

Śruba M10x110-8.8 ; Bolt
Podkl. okr. Ø30x Ø10,5x 3 ; Plain Washer

Nr katalogowy Marka

G/007 Dacia Lodgy (5-7 osób) od 06/2012 ->



96-111 Kowiesy, Chojnata 23 A
tel. +48 46 831 73 31

- Zdjąć koło zapasowe.
- Zdemontować osłonę termiczną.
- Udzielić otwory technologiczne w podłużnicach i przykręcić elementy C i D śrubami M10x110 8.8 (pkt 2) stosując tulejki E.
- Belkę haka A przykręcić śrubami M12x35 8.8 (pkt 1).
- Przykręcić i dopasować osłonę termiczną.
- Zamontować koło zapasowe.
- Dokręcić wszystkie śruby z momentem według tabeli.
- Dokręcić kulę i blachę gniazda elektrycznego.
- Podłączyć instalację elektryczną.

- Insert the distance sleeves in the technological holes, in the metal clamps.
- Screw the elements C , D to the metal clamps with bolts M10x110 8.8 (point 2).
- Screw the main bar A to the elements C with bolts M12x35 8.8 (point 1).
- Tighten all the bolts according to the torque setting- see the table.
- Fix the ball and electric plate.
- Connect the electric wires.

- Placer les douilles d'écartement dans les ouvertures de longerons,
- Visser les éléments d'attache C, D aux longerons par les boulons M10x110, 8.8 (point 2),
- Visser les éléments C à la traverse d'attache A par les boulons M12x35 8.8 (point 1),
- Serrer tous les boulons avec un couple de serrage selon tableau,
- Visser le crochet d'attelage et socle de prise électrique,
- Raccorder le circuit électrique.

- Das Ersatzrad entfernen.
- Die Wärmeisolierung demontieren.
- Die vom Werk aus in den Längsträgern vorhandenen Öffnungen durchlässig machen und die Tragteile C und D mit den Schrauben M10x110 8.8 (Punkt 2) , mit den Hülzen E anschrauben.
- Den Querbalken A mit den Schrauben M12x35 8.8 (Punkt 1) anschrauben.
- Die Wärmeisolierung anpassen und anschrauben.
- Das Ersatzrad einbauen.
- Alle Schrauben mit dem in der Tabelle angegebenen Drehmoment festziehen.
- Die Kugel und die Steckdosenhalterung anschrauben.
- Die Elektroinstallation anschließen

- Desmontar la rueda de repuesto y desmonte la placa térmica
- Limpiar los oricios tecnológicos roscados en la banda trasera del coche.
- Desde el exterior, introducir los casquillos de separación E con tornillos M10x110 8.8 (p. 3) en los oricios tecnológicos en los largueros.
- Atornillar la viga de la bola de remolque A con los elementos de la bola de remolque C y D, usando tornillos M12x35 8.8 (p. 2).
- Montar la rueda de repuesto y y la placa térmica
- Apretar la bola y la placa eléctrica con los tornillos M12x70 8.8.
- Apretar todos los tornillos con el par según la tabla anterior.
- Conectar la instalación eléctrica.

